

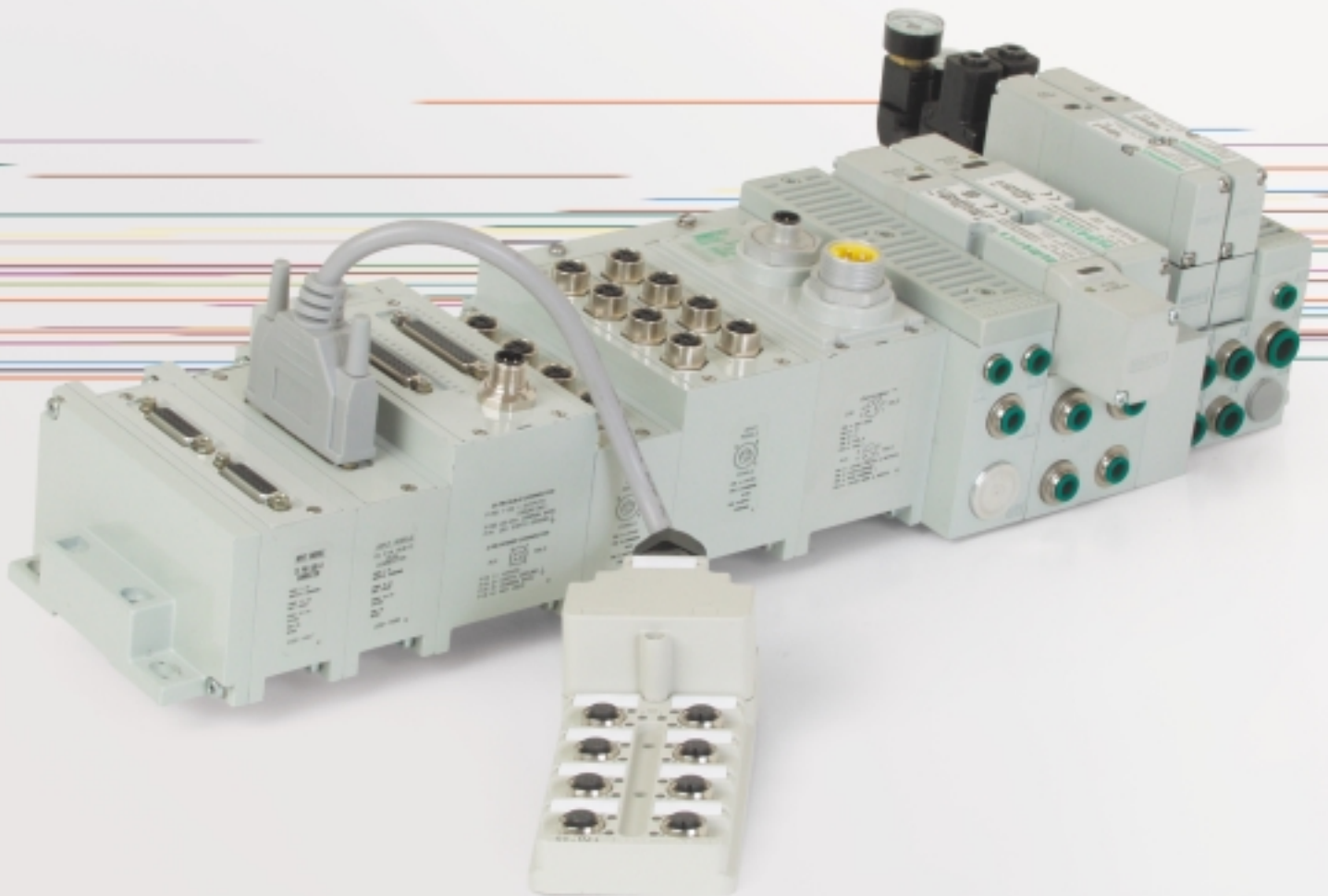

Fieldbus



***Fieldbus Electronics and I/O***

*We're everywhere you need us to be!*



## Fieldbus Electronics and I/O ..... 3-47

### G2-1 Electronics ..... 3-12

Features and Benefits .....	3
Communication Protocols .....	4-7
How to Order .....	8-9
LH Mounting Cover Kit .....	9
Fieldbus Communication Module .....	10
Manual Configuration Module .....	10
I/O Module Assemblies .....	11
Dimensional Drawing .....	12

### G2-2 Electronics ..... 13-33

Features and Benefits .....	13
Communication Protocols .....	14-20
Discrete I/O Modules .....	21
How to Order .....	22-26
Fieldbus Communication Module .....	27
Manual Configuration Module .....	27
I/O Block Assemblies .....	28
25 Pin Sub-D Connector Input .....	29
Dual 15 Pin Sub-D Connector Input .....	29
25 Pin Sub-D Connector Output Module .....	30
Dual 25 Pin Sub-D Connector Output Module .....	30
Valve Side Sub-D Output Modules .....	31
Mounting Cover Assemblies .....	32
Dimensional Drawing .....	33

## Cables and Accessories ..... 34-47



## G2-1 Fieldbus Communications Electronics

Why use Numatics Fieldbus communication electronics? *Modular Reality...*

- No internal wiring
- Up to 40 valve solenoids
- Discrete I/O status with short circuit protection
- Software or manual configuration
- Plug-together flexibility
- Conformance tested
- Shorted and open load diagnostics
- Universal input technology allows NPN or PNP sensor types with same input module.
- NEMA4/IP65
- Up to 16 discrete output points and 16 input points per communication node
- Low cost distribution options
- Used with 2002 Series

Supported Protocols:

- DeviceNet
- Allen Bradley 1771 Remote I/O
- Profibus DP 1.5 MBps & 12MBps
- DeviceLogix
- CANopen - Consult Factory





## G2-1 Electronics

### DeviceNet

DeviceNet is an open protocol bus communication system developed by Allen-Bradley based on Controller Area Network (CAN) technology. The governing body for DeviceNet is the Open DeviceNet Vendor Association (ODVA). The ODVA controls the DeviceNet specification and oversees product conformance testing.

Numatics G2-1 DeviceNet modules have been tested and approved for conformance by the ODVA.

More information about DeviceNet and the ODVA can be obtained from the following WEB site:

Open DeviceNet Vendors Association (ODVA)  
[www.odva.org](http://www.odva.org)



### Technical Data

ELECTRICAL DATA	VOLTAGE	CURRENT
BUS Power	11-25 VDC	0.025 amps.
Valve & Discrete I/O	24 VDC +/- 10%	4 amps. maximum
Aux Power Connector	Single key way 4 pole 12mm (Micro) connector	
Communication Connector	Single key way 5 pole 12 mm (Micro) connector	
LED's	Module status, Network status, Ext fault & Aux power	
OPERATING DATA		
Temperature Range	+32° to +115° F (0° to +46° C)	
Humidity	95% relative humidity, non-condensing	
Moisture	Designed to meet NEMA 4 / IP65 requirements	
CONFIGURATION DATA		
Communication Module	Contains all communication electronics as well as short circuit protected driver circuitry for up to 24 valve solenoids. Supports auto-baud detection and auto-device replacement (ADR) feature.	
Manual Configuration Module (MCM)	Optional module for use when a manual configuration method is preferred.	
Maximum Valve Solenoid Outputs	24	
Maximum Discrete I/O Points	16	
Numatics' DeviceNet modules features polled, change of state (COS), cyclic and combinations message capability.		
Electronic Data Sheet (EDS) file and technical manuals are available in the download section of the Numatics, Inc. web site at: <a href="http://www.numatics.com/fieldbus">www.numatics.com/fieldbus</a>		



## G2-1 Electronics

### Allen Bradley 1771 Remote I/O

Allen-Bradley 1771 Remote I/O is a proprietary protocol based on a patented chipset. This chipset is obtained from Allen-Bradley and incorporated into the Numatics RIO module.

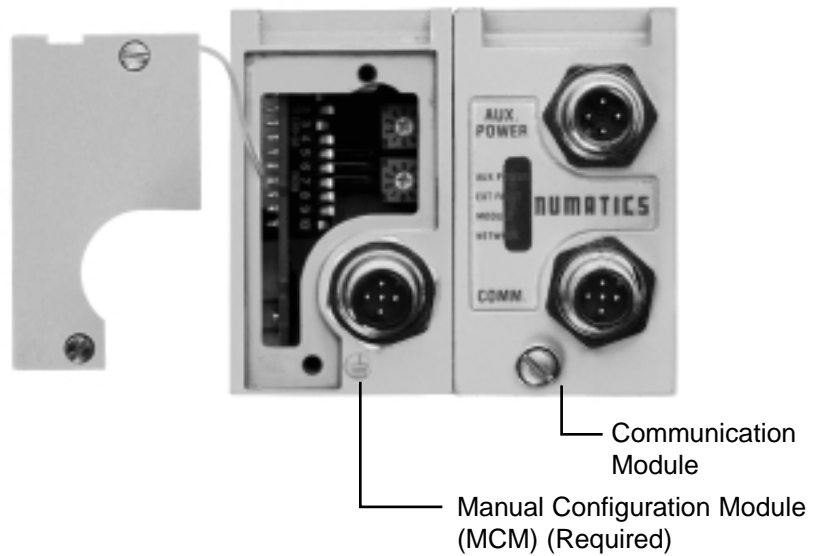

This product incorporates technology which is licensed by Allen-Bradley Company, Inc. Allen-Bradley has not technically approved, nor does it warrant or support this product. All warranty and support for this product and its application is provided solely by Numatics, Incorporated.

### Technical Data

ELECTRICAL DATA	VOLTAGE	CURRENT
Valve & Discrete I/O	24 VDC +/- 10%	4 amps. maximum
Aux Power Connector	Single key way 4 & 5 pole 12mm (Micro) connector	
Communication Connector	Single key way 5 pole 12 mm (Micro) connector, Bus in and out	
LED's	Communications status, ext. fault and auxiliary power	

OPERATING DATA		
Temperature Range	+32° to +115° F (0° to +46° C)	
Humidity	95% relative humidity, non-condensing	
Moisture	Designed to meet NEMA 4 / IP65 requirements	

CONFIGURATION DATA	
Communication Module	Contains all communication electronics as well as short circuit protected driver circuitry for up to 24 valve solenoids.
Manual Configuration Module (MCM)	Module contains DIP and rotary switches for setting device configuration data
Maximum Valve Solenoid Outputs	24
Maximum Discrete I/O Points	16
Rack Size	Rack size set automatically to 1/4 rack



## G2-1 Electronics

### Profibus DP (1.5 MBps & 12 MBps)

Profibus-DP is a vendor-independent, open fieldbus designed for communication between automation control systems and distributed I/O at the device level.

The 2002 Series - Profibus product is designed to conform to the Profibus standard EN50170. Certification is by the Profibus Interface Center (PIC) according to the guidelines determined by the Profibus Trade Organization (PTO). The certification process ensures interoperability for all Profibus devices.

More information about Profibus can be obtained at the following web sites:

**Profibus Interface Center**  
[www.aut.sea.siemens.com/pic/index.htm](http://www.aut.sea.siemens.com/pic/index.htm)

**Profibus Trade Organization**  
[www.profibus.com](http://www.profibus.com)

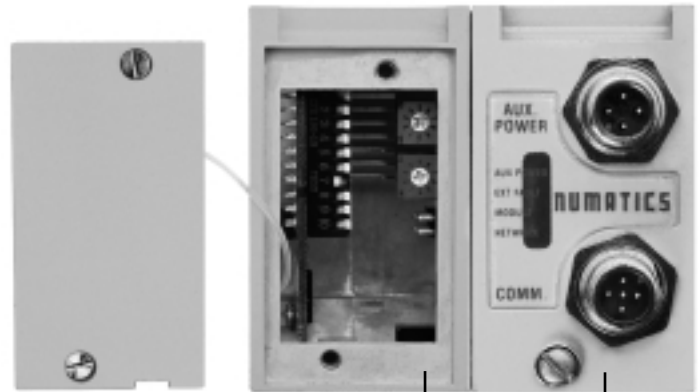

Manual Configuration Module  
 (MCM) (Not required with Class II Master)

Communication Module

### Technical Data

ELECTRICAL DATA		VOLTAGE	CURRENT
Valve & Discrete I/O		24 VDC +/- 10%	4 amps. maximum
Aux. Power Connectors	1.5 MBps 12 MBps	Single key way 4 pole 12 mm (Micro) connector Single key way 4 pole 12 mm (Micro) connector	
Communication Connector	1.5 MBps 12 MBps	5 pole 12 mm (Micro) connector 5 pole reverse key female (Micro) connector	
LED's		Module status, Network status, Ext fault and Auxiliary power	
OPERATING DATA			
Temperature Range		+32° to +115° F (0° to +46° C)	
Humidity		95% relative humidity, non-condensing	
Moisture		Designed to meet NEMA 4 / IP65 requirements	
CONFIGURATION DATA			
Communication Module		Contains all communication electronics as well as short circuit protected driver circuitry for up to 24 valve solenoids.	
Manual Configuration Module (MCM)		Module containing DIP and rotary switches for setting device configuration data.	
Maximum Valve Solenoid Outputs		24	
Maximum Discrete I/O Points		16, available with 12mm (micro) connectors or 25 pin sub-D styles	

(GSD) File and technical manuals are available in the download section of the Numatics, Inc. website at: [www.numatics.com/fieldbus](http://www.numatics.com/fieldbus).





## Discrete I/O Modules

Discrete I/O modules are used to connect additional I/O devices to the valve manifold node. This provides for more efficient use of system resources when configuring a communication system.

Universal input modules feature technology that allows the same module to automatically recognize PNP or NPN type sensors without the need to add external pull-up resistors or manually select sensor type.

Input and output modules have two 12mm (micro) connectors. Each can be used individually (i.e. 1 I/O point per connector) or can be used for double point (i.e. connector 1 has two points of I/O). This standard feature further simplifies external I/O wiring.

Sub-D output module can be used to drive 16 additional coils on a separate manifold or 16 discrete output points.

Sub-D I/O module can be used for inputs and or up to a total of 16 I/O points.



Discrete I/O



Sub-D I/O

## Technical Data

### ELECTRICAL DATA

#### Inputs:

Supply Voltage	24 VDC $\pm$ 10%
Type	Sourcing (PNP), Sinking (NPN) or contact closure (universal input technology)
LED Indicator	Input status

#### Outputs:

Voltage	24 VDC $\pm$ 10%
Current	0.5 amperes per output (4A max. per manifold)
Type	Sinking (NPN)
LED Indicator	Output status

### OPERATING DATA

Temperature Range	+32° to +115° F (0° to +46° C)
Humidity	95% relative humidity, non-condensing
Moisture	Designed to meet NEMA 4 / IP65 requirements
Connectors	Single keyway 5 pole female 12mm (micro) connector or 25 pin sub-D female

### CONFIGURATION DATA

The maximum number of modules connected to the discrete I/O side is 8. A fully configured manifold assembly would require 2 master modules with 6 slaves.



## G2-1 Electronics

### How to Order

#### 1) Assembly Kit Selection **A K C 6 0 0 0 0**

##### Electrical / Electronic Type & Location

C = Communication Module

##### Valve Series

6 = 2002 Series

##### Number of Valve Stations\*

A = 1 I = 9 Q = 17  
 B = 2 J = 10 R = 18  
 C = 3 K = 11 S = 19  
 D = 4 L = 12 T = 20  
 E = 5 M = 13 U = 21  
 F = 6 N = 14 V = 22  
 G = 7 O = 15 W = 23  
 H = 8 P = 16 X = 24

##### End Plate

##### Port Size

2 = 1/4  
 H = 8mm (5/16)

##### Port Type

L = Push In  
 D = Barbed Fitting

##### Options

STD = Standard  
 DRM = DIN Rail Mounting (Std. 35mm)  
 MUF = Muffler in End Plates  
 DWM = DIN Rail with MUF  
 A01 = 25 Pin Sub-D 16 Discrete Outputs Sinking (NPN)  
 D01 = A01 + DRM  
 D03 = A01 + MUF  
 F01 = A01 + DRM + MUF  
 A17 = 25 Pin Sub-D 16 I/O Points Inputs Sourcing (PNP) Outputs Sinking (NPN)  
 D18 = A17 + DRM  
 D19 = A17 + MUF  
 F07 = A17 + DRM + MUF

\* Maximum number of valve stations is determined by the combination of single and double Z-Boards types installed in the manifold sub-bases. All G2-1 communication modules support 24 output drivers for valve solenoid coils.

#### 2) Valve Model Number Selection

Valve model number with plug-in manifold base and "G" wiring option.

#### 3) Electronic Interface **N X 6 D F E02**

##### Fieldbus Protocols

DN = DeviceNet™  
 AB = Allen Bradley RIO  
 PB = Profibus DP 1.5 MBps  
 PT = Profibus DP 12 MBps  
 DL = DeviceLogix

##### Number of Discrete Inputs\*\*

##### Number of Discrete Outputs\*\*

##### Options

E02 = Separate Power (Valve and I/O)  
 G08 = With MCM if Not Standard  
 STD = Standard

##### Voltage

F = 24 VDC

##### I/O Type

D = Digital

#### \*\*4) I/O Per I/O Station – Electronic Interface Option Only (See I/O table below)

When ordering up to eight (8) I/O you must order one (1) Master I/O (which contains two (2) points I/O itself). The balance required is made up of Slaves, two (2) points per I/O station (total 3 Slave modules). A maximum of sixteen (16) I/O points can be configured by using two (2) Master modules and six (6) Slave modules. Total number of discrete inputs plus total number of discrete outputs must be less than or equal to 16. (See I/O table below).

Input master modules can be used with Output Slave Modules.

Output master Modules can be used with Input Slave Modules.

Sub-D outputs and I/O types do not require additional master modules when used alone

#### I/O Table: Note 2 I/O per station

HOUSING TYPE	SINKING (NPN) OUTPUT	SINKING (NPN) or SOURCING (PNP) INPUT
Master Kit No.	239-1800	239-1802
Slave Kit No.	239-1801	239-1803





## AKC Communication Module

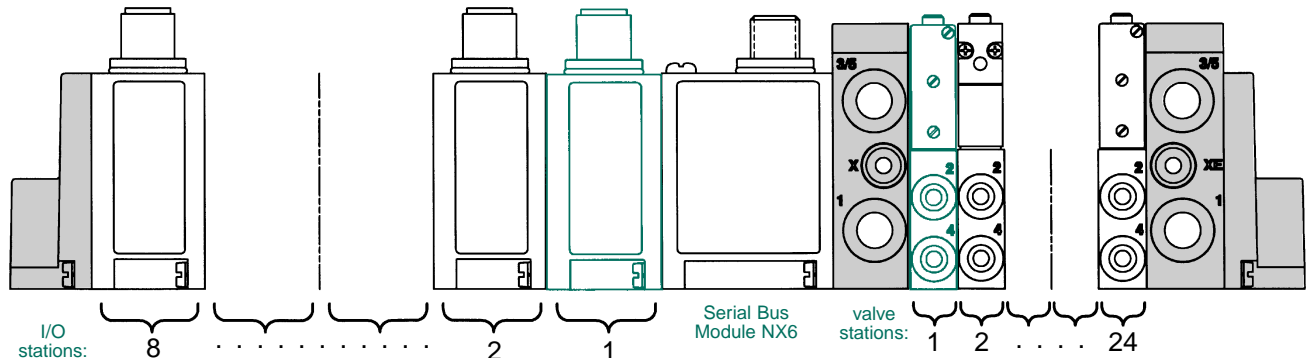

- Shaded components described by Assembly Kit (AK) model number designation (see #1, pg. 8), with the exception of the Communication module and number of I/O stations that are described by Electronic Interface (NX6) model number designation. (see #3, pg. 8)
- Each valve manifold station is listed in sequential order from left to right when facing the port side of the manifold as indicated.
- Each discrete I/O station is listed in sequential order from RIGHT to LEFT starting from the Communication module as indicated.

NOTE: I/O stations #1 and #5 (if required) must always be a MASTER KIT. (see #4, pg. 8)

Stations 2,3,4,6,7 and 8 must be either input or output Slave kits.

NOTE: Total of 24 solenoid outputs available. Either 24 single solenoid valves or 12 double solenoid valves or any combination of singles or doubles, not to exceed 24 solenoid outputs for AKC Serial/Bus are allowed.

Example order: AKC6D00002LSTD  
 021BW4Z3GL00061  
 021BW4Z3GL00061  
 021BB4Z4GL00061  
 021BB4Z4GL00061  
 NX6DN0808DFE02

I/O station 1	239-1802	Input Master Sinking (NPN) Kit
I/O station 2	239-1803	Input Slave Sinking (NPN) Kit
I/O station 3	239-1803	Input Slave Sourcing (PNP) Kit
I/O station 4	239-1803	Input Slave Sourcing (PNP) Kit
I/O station 5	239-1800	Output Master Sinking (NPN) Kit
I/O station 6	239-1801	Output Slave Sinking (NPN) Kit
I/O station 7	239-1801	Output Slave Sinking (NPN) Kit
I/O station 8	239-1801	Output Slave Sinking (NPN) Kit
		ASSEMBLED

## LH Mounting Cover Kit

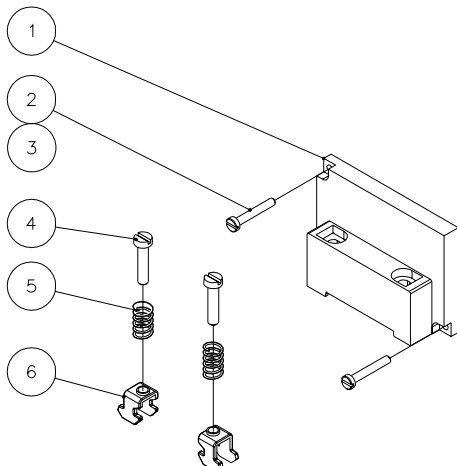

DET. NO.	NO. REQ'D	PART NAME	PART NO.
1	1	LH DIN Rail Mtg Cover	105-381
2	2	Screw	127-844
3	2	Lockwasher	128-192
4	2	Screw	127-472
5	2	Spring	115-355
6	2	Clamp	125-720

LH MOUNTING COVER KIT	PART NO.
With DIN Rail	239-1819
Without DIN Rail	239-1820



## G2-1 Electronics

# Fieldbus Communication Module and Manual Configuration Module Assemblies

## Communication Module

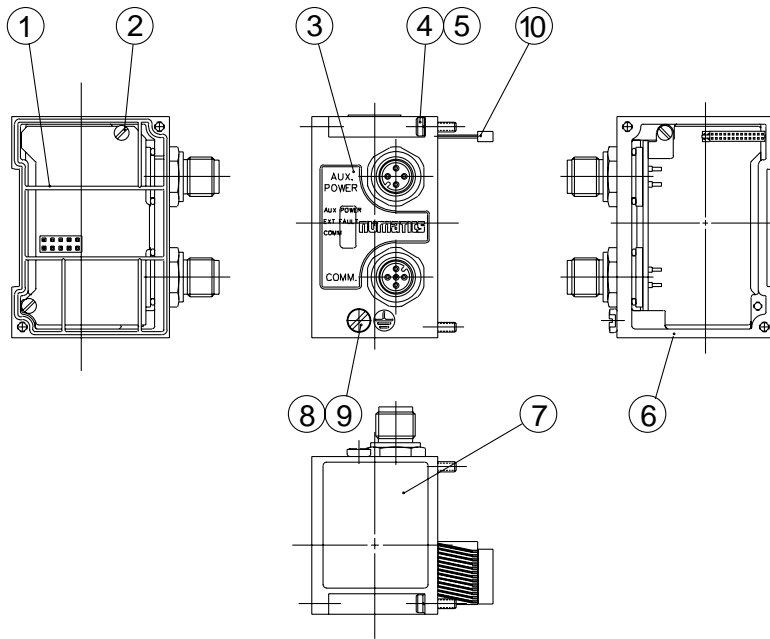

DET. NO.	NO. REQ'D	PART NAME	PART NO.
1	1	Gasket	113-503
2	3	Screw	127-794
3	1	Nameplate (DeviceNet)	122-1122
3	1	Nameplate (Profibus)	122-1123
3	1	Nameplate (Allen Bradley RIO)	122-1124
4	2	Screw	127-795
5	2	Lockwasher	128-192
6	1	Housing	125-1017
7	1	Nameplate	122-1058
8	1	Screw	127-176
9	1	Cup Washer	128-162
10	1	Transfer Board	256-589

## Communication Module Kits (w/o End Plates)

DESCRIPTION	PART NO.
DeviceNet	239-1794
Remote I/O	239-1804
Profibus 1.5 Mbps	239-1805
Profibus 12 Mbps	239-1806
DeviceLogix	239-2108
CANopen	Consult Factory

## Manual Configuration Module (MCM)

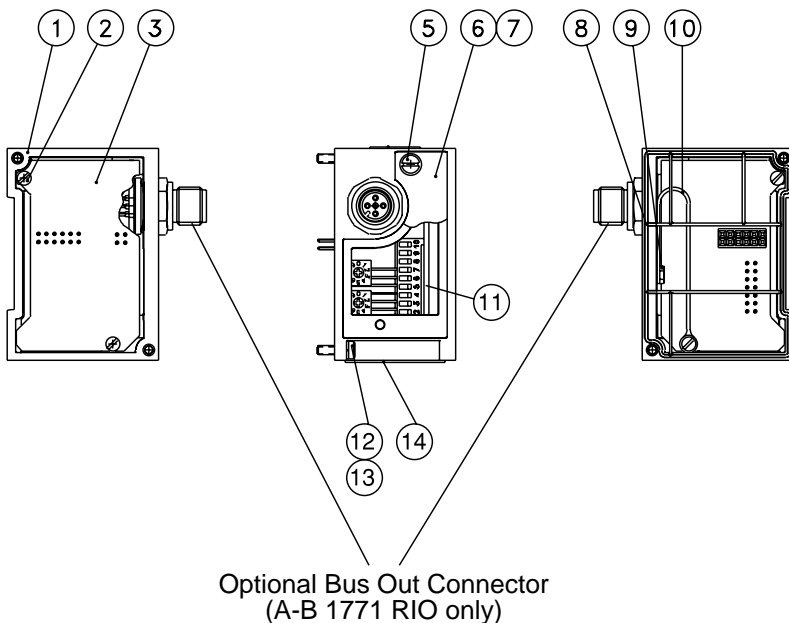

DET. NO.	NO. REQ'D	PART NAME	PART NO.
1	1	Switch Housing w/ conn.	125-800
1	1	Switch Housing w/o conn.	125-1038
2	4	Screw	127-794
5	2	Screw	127-852
6	1	Cover w/ conn.	105-399
6	1	Cover w/o conn.	105-384
7	1	Gasket w/conn.	113-529
7	1	Gasket w/o conn.	113-508
8	1	Gasket	113-503
9	1	Screw	127-172
10	1	Cover Strap	125-772
12	2	Screw	127-795
13	2	Lockwasher	126-192
14	1	Nameplate (Conn Ver. Only)	122-1058

## Manual Configuration Module Kits (w/o End Plates)

DESCRIPTION	PART NO.
With Connector (A-B 1771 RIO only)	239-1812
Without Connector	239-1813



I/O Modules Assemblies

I/O Module Kit with Input LED Indicator (2 I/O per module)

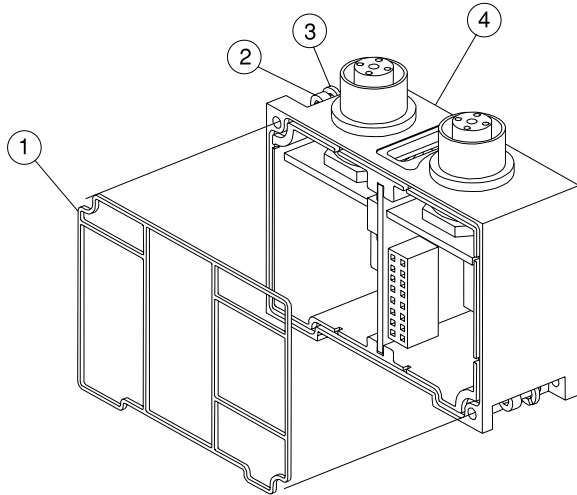

DET. NO.	NO. REQ'D	PART NAME	PART NO.
1	1	Gasket	113-503
2	2	Screw	127-795
3	2	Lockwasher	128-192
4	1	Housing	125-807

HOUSING TYPE	OUTPUT
<b>Master Kit No.</b>	
Output - Sinking (NPN)	239-1800
Input - Sinking (NPN) or Sourcing (PNP)	239-1802
<b>Slave Kit No.</b>	
Output - Sinking (NPN)	239-1801
Input - Sinking (NPN) or Sourcing (PNP)	239-1803
<b>Connector Type</b>	
I/O	12 mm (Micro) 5 Pin Female

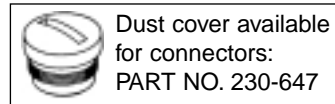

25 Pin Female Sub-D Discrete Output and I/O Module

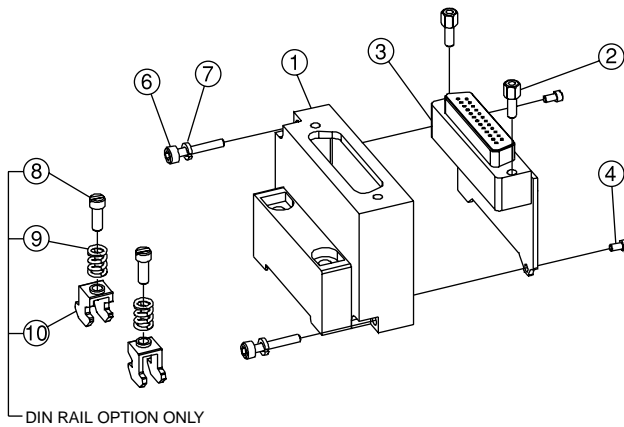

DET. NO.	NO. REQ'D	PART NAME	PART NO.
1	1	Housing	105-379
2	2	Hex Screw	127-825
3	1	Gasket	113-507
4	2	Screw	127-794
6	1	Nameplate	122-1057
7	2	Screw	127-499
8	2	Lockwasher	128-192
9	2	Screw (w/DIN)	127-472
10	2	Spring (w/DIN)	115-355
11	2	Clamp (w/DIN)	125-720

Discrete output and I/O Module Kit

DESCRIPTION	PART NO.
16 pt. Output Sinking (NPN) with DIN Rail	239-1225
16 pt. Output Sinking (NPN) w/o DIN Rail	239-1221
16 pt. Input Sourcing (PNP) and/or Output Sinking (NPN) with DIN Rail	239-1866
16 pt. Input Sourcing (PNP) and/or Output Sinking (NPN) w/o DIN Rail	239-1865

Note: When ordering this module in an assembled manifold "AK" use the corresponding option code in the "AK" model number. Do not list the module part number under the Electronic Interface model number "NX".



## G2-1 Electronics

### FlexiBlok® Manifold with Fieldbus Electronics Dimensional Drawing

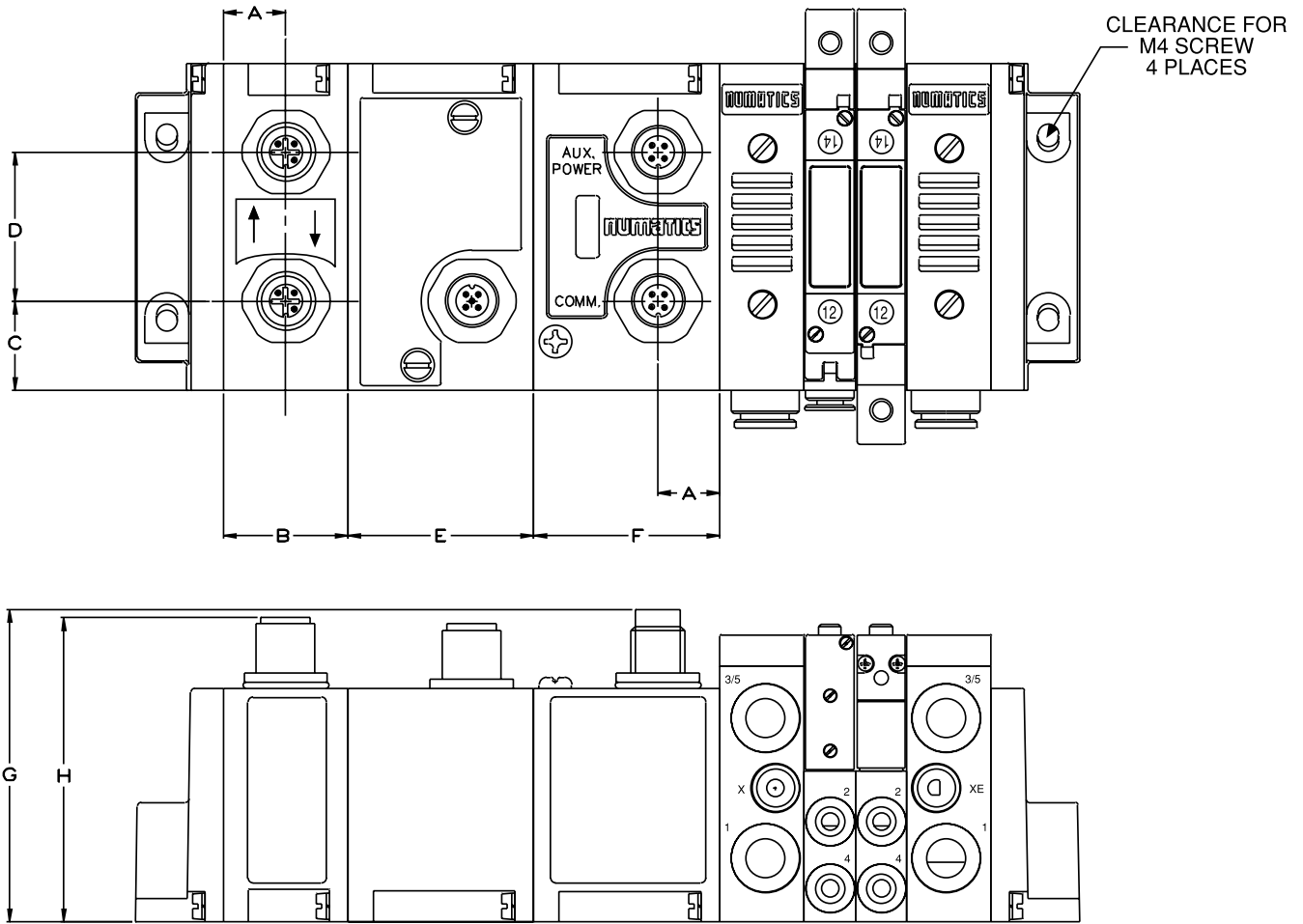

### Dimensions

top dimensions = inches  
bottom dimensions (in parenthesis) = millimeters

A	B	C	D	E	F	G	H
0.50 (12.7)	1.00 (25.4)	0.72 (18.3)	1.20 (30.5)	1.50 (38.1)	1.50 (38.1)	2.38 (60.5)	2.32 (59.0)



## G2-2 Fieldbus Communications Electronics

Why use Numatics Fieldbus communication electronics? *Modular Reality*

- No internal wiring simplifies assembly
- Up to 192 discrete output points and 32 valve solenoids and 96 input points per communication mode
- Enhanced diagnostics include discrete I/O status with short circuit protection
- Software or manual configuration simplifies commissioning
- Plug-together flexibility
- Backplane technology allows fast maintenance
- Conformance tested ensures compatibility
- Shorted and open load diagnostics
- NPN and PNP discrete I/O modules
- NEMA 4/IP65 protected against water splash
- Low cost distribution options provide economic solutions for applications
- DIN rail mountable

Supported Protocols:

- Allen Bradley 1771 Remote I/O
- ControlNet
- DeviceNet
- DeviceNet with DeviceLogix
- Ethernet
- Interbus-S
- Profibus DP 1.5 MBps & 12MBps
- ASI - Consult Factory

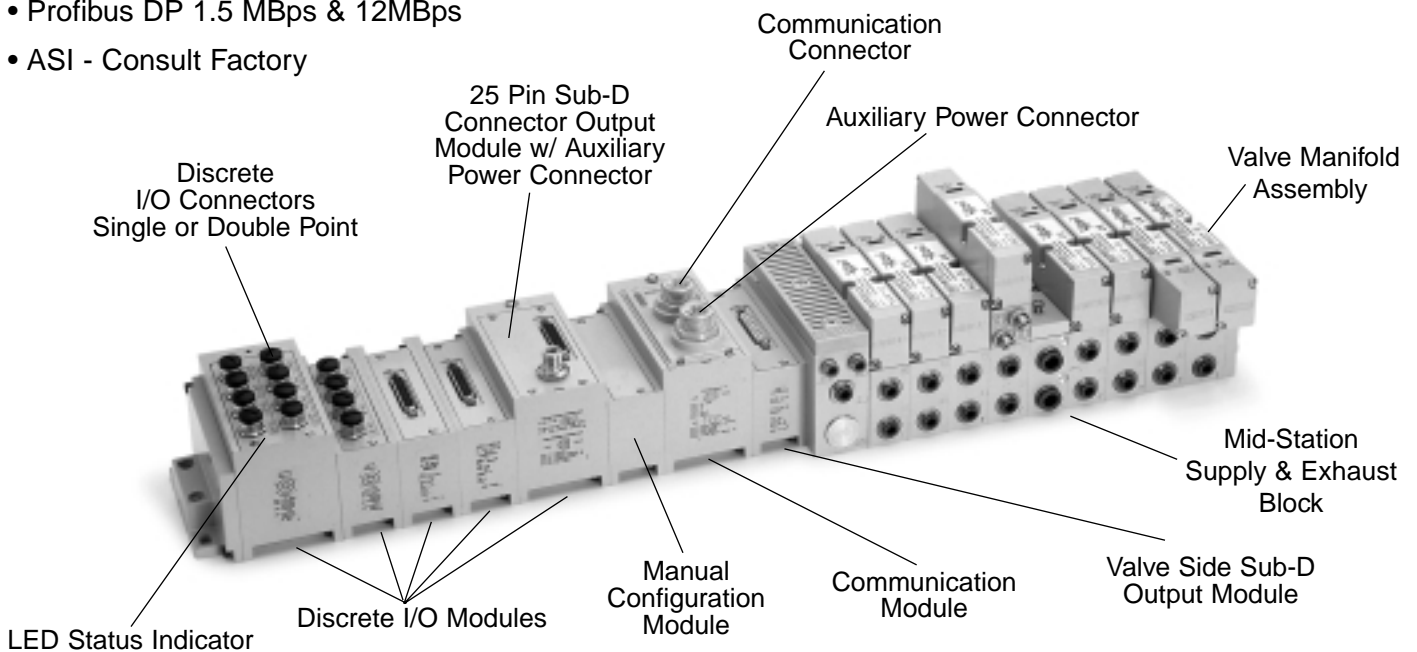



## G2-2 Electronics

### DeviceNet

DeviceNet is an open protocol bus communication system developed by Allen-Bradley based on Controller Area Network (CAN) technology. The governing body for DeviceNet is the Open DeviceNet Vendors Association (ODVA). The ODVA controls the DeviceNet specification and oversees product conformance testing.

Numatics G2-2 DeviceNet nodes are capable of addressing up to 192 output/96 input. They have been tested and approved for conformance by the ODVA.

More information about DeviceNet and the ODVA can be obtained from the following WEB site:

Open DeviceNet Vendors Association (ODVA)  
[www.odva.org](http://www.odva.org)

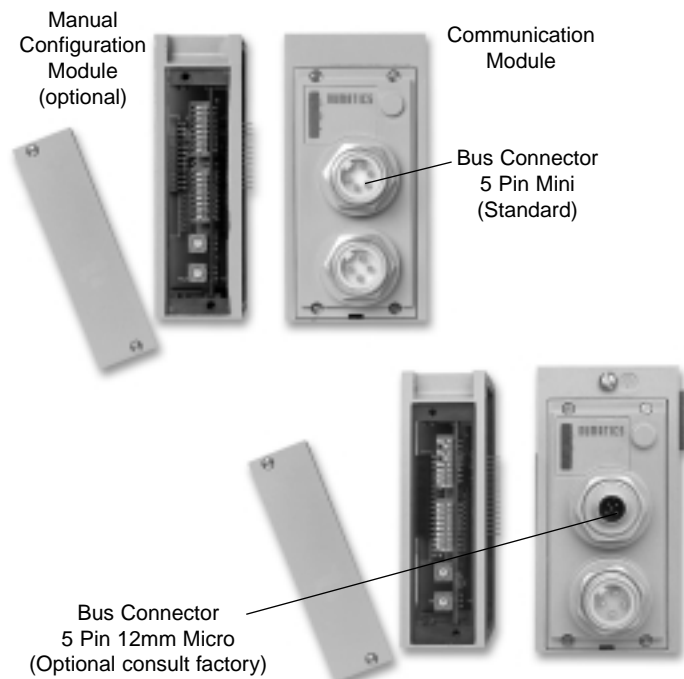

### Technical Data

ELECTRICAL DATA	VOLTAGE	CURRENT
Node Power	24V ± 10%	0.040 amps.
BUS Power	11-25 VDC	0.025 amps.
Valve & Discrete I/O	24 VDC +/- 10%	8 amps. maximum
Aux Power Connector	Single key way 4 pin mini type (male)	
Communication Connector	Single key way 5 pole (Mini or Micro type) male	
LED's	Module status, network status, fuse integrity & aux power status	
OPERATING DATA		
Temperature Range	-10° to +115° F (-23° to +46° C)	
Humidity	95% relative humidity, non-condensing	
Moisture	Designed to meet NEMA 4 / IP65 requirements	
CONFIGURATION DATA		
Communication Module	Contains all communication electronics as well as short circuit protected driver circuitry for up to 32 valve solenoids.	
Manual Configuration Module (MCM)	Optional module containing DIP and rotary switches for setting device configuration data. Note: Use option "G08" in "NX" model number	
Maximum Valve Solenoid Outputs	32	
Maximum Discrete I/O Points	Software configurable (standard): Various combinations of 192 outputs & 96 inputs With optional manual configuration module: Various combinations of 160 outputs & 80 inputs	
NETWORK DATA		
Supported Baud Rates	125 K Baud, 250 K Baud, 500 K Baud with Auto-Baud detection	
Supported Connection Types	Polled, cyclic & change of state (COS)	
Bus Connector	Single keyway 5 pin mini or 12mm micro types (male)	
Diagnostics	Shorts & open load conditions from valve solenoid coils & outputs are monitored	
Special Features	Supports Auto-Device Replacement (ADR)	

Electronic Data Sheet (EDS) file and technical manuals are available in the download section of the Numatics, Inc. web site at: [www.numatics.com/fieldbus](http://www.numatics.com/fieldbus)





## ControlNet

ControlNet is an open network that meets the demands of today's industrial applications requiring high speed (5 MBIT/sec.), high throughput with predictable and repeatable transfers of mission critical data.

Originally developed by Allen-Bradley, it is based on the Control and Information Protocol (CIP) technology. The governing body for the ControlNet technology is ControlNet International LTD.

More information about ControlNet can be obtained from the following website:  
[www.controlnet.org](http://www.controlnet.org)



## Technical Data

ELECTRICAL DATA	VOLTAGE	CURRENT
Node Power	24V ± 10%	0.097 amps.
Valve & Discrete I/O	24 VDC +/- 10%	8 amps. maximum
Aux Power Connector	Single key way 4 pin mini type (male)	
LED's	Module owned, module status, channel A & B, fuse integrity & aux power status	
Communication Connector	BNC Type	

OPERATING DATA		
Temperature Range	-10° to +115° F (-23° to +46° C)	
Humidity	95% relative humidity, non-condensing	
Moisture	Designed to meet NEMA 4 / IP65 requirements with proper connector hoods	

CONFIGURATION DATA		
Power Module	Contains power interface electronics as well as short circuit protected driver circuitry for up to 32 valve solenoids.	
Comm. Interface Module	Contains communication interface electronics and network address (MAC ID) configuration hardware.	
Maximum Valve Solenoid Outputs	32	
Maximum Discrete I/O Points	Various combinations of 192 outputs & 96 inputs	

NETWORK DATA		
Supported Baud Rates	5 MBIT/sec	
Connectors	BNC type for network; RJ-45 for Network Access Point (NAP)	
Diagnostics	Shorts & open load conditions from valve solenoid coils & outputs are monitored	
Special Features	Support for redundant media via 2 BNC connectors	

Electronic Data Sheet (EDS) file and technical manuals are available in the download section of the Numatics, Inc. web site at: [www.numatics.com/fieldbus](http://www.numatics.com/fieldbus)



## G2-2 Electronics

### Allen Bradley 1771 Remote I/O

Allen-Bradley 1771 Remote I/O is a proprietary protocol based on a patented chipset. This chipset is obtained from Allen-Bradley and incorporated into the Numatics RIO module.

Numatics G2-2 Communications Node is capable of addressing up to 1 full rack of I/O.

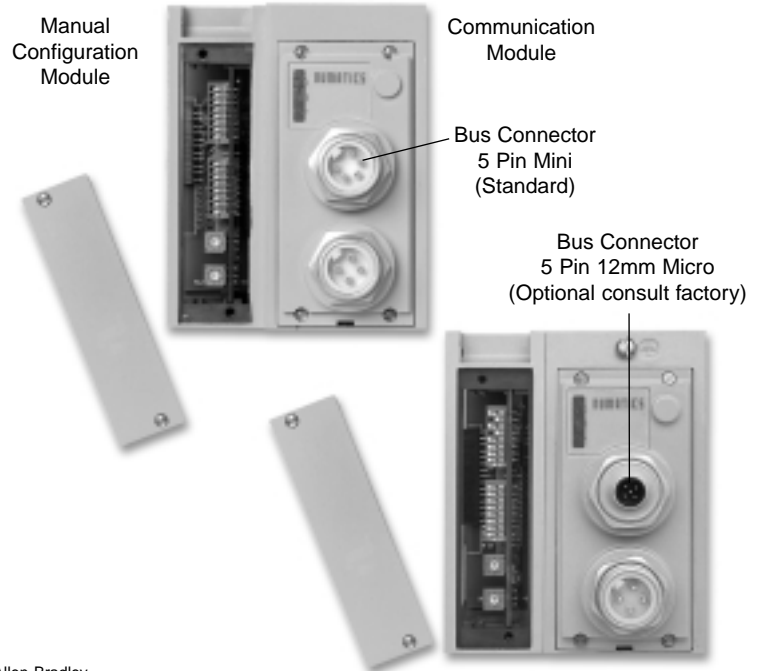

This product incorporates technology which is licensed by Allen-Bradley Company, Inc. Allen-Bradley has not technically approved, nor does it warrant or support this product. All warranty and support for this product and its application is provided solely by Numatics, Incorporated.

### Technical Data

ELECTRICAL DATA	VOLTAGE	CURRENT
Node Power	24 VDC ±	0.065 amps.
Valve & Discrete I/O	24 VDC +/- 10%	8 amps. maximum
Aux Power Connector	Single keyway 4 pin mini type	
Communication Connector	Single key 5 pole (Mini or Micro type) male	
LED's	Communications status, fuse integrity and aux. power status	
OPERATING DATA		
Temperature Range	-10° to +115° F (-23° to +46° C)	
Humidity	95% relative humidity, non-condensing	
Moisture	Designed to meet NEMA 4 / IP65 requirements	
CONFIGURATION DATA		
Communication Module	Contains all communication electronics as well as short circuit protected driver circuitry for up to 32 valve solenoids.	
Manual Configuration Module (MCM)	Module containing DIP and rotary switches for setting device configuration data.	
Maximum Valve Solenoid Outputs	32	
Maximum Discrete I/O Points	Various combinations of 110 outputs & 80 inputs	
Rack Size:	Rack size set automatically to 1/4, 1/2, 3/4, or full rack based on the I/O modules installed on the manifold assembly.	
NETWORK DATA		
Supported Baud Rates	57.6 K Baud, 115.2 K Baud and 230.4 K Baud	
Bus Connector	Single keyway 5 pin mini or 12mm micro type	
Special Features	Support for processor restart/lockout and hold last state	



## DeviceLogix

DeviceLogix is a Rockwell Automation technology that allows a DeviceNet node to be programmed to execute a sequence independently from the control for the main PLC/IPC. A DeviceLogix enabled DeviceNet node can be used in conjunction with a standard DeviceNet network, providing simple distributed control functionality. Additionally, it can also be used in a standalone application, without a network connection, to sequence pneumatic valves and control I/O. Numatics has integrated this license technology into its DeviceNet compatible valve manifold series, which combine the functionality of a modular pneumatic valve system with integrated I/O.

Programming of the DeviceLogix enabled node is done using the industry standard DeviceNet commissioning software tool RSNetworkx for DeviceNet for Rockwell Automation. The programming environment features an easily understandable graphics environment where the users can simply “drag and drop” logic function blocks (i.e. AND, NAND, OR, NOR, XOR, XNOR, RS LATCHES, COUNTERS and TIMERS) onto a page and interconnect them to develop the required sequence. The programmed sequence is downloaded to the node via the standard DeviceNet communication connection, thus multiple nodes can be programmed simultaneously on the same network.



## Technical Data

ELECTRICAL DATA	VOLTAGE	CURRENT
Node Power	24 VDC +/- 10%	
Bus Power	11-25 VDC	0.025 amps
Valve & Discrete I/O	24 VDC +/- 10%	8 amps. maximum
Aux Power Connector	Single key way 4 pin mini type (male)	
Communication Connector	Single key way 5 pole (Mini type) male	
LED's	Module status, network status, auxiliary power status, fuse integrity and logic enabled.	
OPERATING DATA		
Temperature Range	-10° to +115°F (-23° to +46°C)	
Humidity	95% relative humidity, non-condensing	
Moisture	Designed to meet NEMA 4 / IP65 requirements	
CONFIGURATION DATA		
Comm. Interface Module	Contains all communication and control electronics as well as short circuit protected driver circuitry for up to 32 valve solenoids	
Maximum Valve Solenoid Outputs	32	
Maximum Discrete I/O Points	Various combinations of up to 196 outputs & 96 inputs; logical limit of 72 function block	
NETWORK DATA		
Supported Baud Rates	125 K Baud, 250 K Baud and 500 K Baud with auto-baud detection	
Connectors	Single keyway 5 pin mini or 12mm micro type (male)	
Diagnostics	Shorts and open load conditions from valve solenoid coils and outputs are monitored	
Special Features	Does not require a network connection for stand-alone applications	

Electronic Data Sheet (EDS) file and technical manuals are available in the download section of the Numatics, Inc. web site at: [www.numatics.com/fieldbus](http://www.numatics.com/fieldbus)



## Ethernet

Ethernet, used throughout the world to network millions of PC's has now evolved into a viable industrial network. Ethernet is an open architecture high-level communication network that meets the demands of today's industrial applications requiring high-speed (10/100 Mbit/s), high-throughput and flexibility. Various application layers for this protocol include **TCP/IP**, **EtherNet/IP**, and **Modbus TCP/IP**. Additionally, Ethernet technology can integrate an on-board Web Server, which can make the node readily accessible to any standard Web browser for configuration, testing and even retrieval of technical documentation. E-mail capability allows the manifold to send e-mails that are triggered from specific events ranging from diagnostic information to automatic Preventative Maintenance scheduling. Numatics has integrated this technology into the G2-2 series of fieldbus manifolds, which combines the functionality of a scalable modular I/O system with a modular pneumatic valve manifold.



## Technical Data

ELECTRICAL DATA	VOLTAGE	CURRENT
Node Power	24 VDC +/- 10%	
Valve & Discrete I/O	24 VDC +/- 10%	
Aux Power Connector	Single keyway 4 pin mini type (male)	
LED's	Module status, link, active, net status, auxiliary power status and fuse integrity	
OPERATING DATA		
Temperature Range	-10° to +115°F (-23° to +46°C)	
Humidity	95% relative humidity, non-condensing	
Moisture	Designed to meet NEMA 4 / IP65 requirements	
CONFIGURATION DATA		
Power Module	Contains all power interface electronics as well as short circuit protected driver circuitry for up to 32 valve solenoids	
Comm. Interface Module	Contains all communication interfaced electronics	
Maximum Valve Solenoid Outputs	32	
Maximum Discrete I/O Points	Various combinations of up to 192 outputs & 96 inputs	
NETWORK DATA		
Supported Baud Rates	10 Mbit / 100 Mbit	
Connectors	RJ45 or 8 Pin 12 mm	
Diagnostics	Shorts and open load conditions from valve solenoid coils and outputs are monitored	
Special Features	Integrated web server and e-mail capabilities	



## Interbus - S

Interbus-S is an open architecture, high performing, ring based fieldbus system used in many of today's industrial network applications. I/O data is transmitted in frames that provide simultaneous and predictable updates to all devices on the network.

More Information about Interbus-S can be obtained at the following Interbus-S Club web site: [www.ibsclub.com](http://www.ibsclub.com).



## Technical Data

ELECTRICAL DATA	VOLTAGE	CURRENT
Node Power	24 VDC +/- 10%	
Valve & Discrete I/O	24 VDC +/- 10%	
Aux Power Connector	Single keyway 4 pin mini type (male)	
Communication Connector	9 pin Sub-D, in and out	
LED's	TR, CC, RBDA, BA, auxiliary power status and fuse integrity	
OPERATING DATA		
Temperature Range	-10° to +115° F (-23° to +46° C)	
Humidity	95% relative humidity, non-condensing	
CONFIGURATION DATA		
Power Module	Contains all power interface electronics as well as short circuit protected driver circuitry for up to 32 valve solenoids	
Comm. Interface Module	Contains all communication interfaced electronics	
Maximum Valve Solenoid Outputs	32	
Maximum Discrete I/O Points	Various combinations of up to 160 outputs & 96 inputs	
NETWORK DATA		
Supported Baud Rates	500 Kbit/s & 2 Mbit/s	
Connectors	Two 9 pin sub-d (1 male and 1 female)	
Diagnostics	Shorts and open load conditions from valve solenoid coils and outputs are monitored	



## G2-2 Electronics

### Profibus DP (1.5 MBps & 12 MBps)

Profibus DP is a vendor-independent, open field-bus protocol designed for communication between automation control systems and distributed I/O at the device level.

Numatics' G2-2 Profibus DP nodes are capable of addressing up to 164 outputs/96 inputs. They are designed and tested to conform to the Profibus standard EN50170. Certification is by the Profibus Interface Center (PIC) according to the guidelines determined by the Profibus Trade Organization (PTO). The certification process ensures interoperability for all Profibus devices.

More information about Profibus DP can be obtained at the following web site:

Profibus Trade Organization (PTO)  
[www.profibus.com/](http://www.profibus.com/)

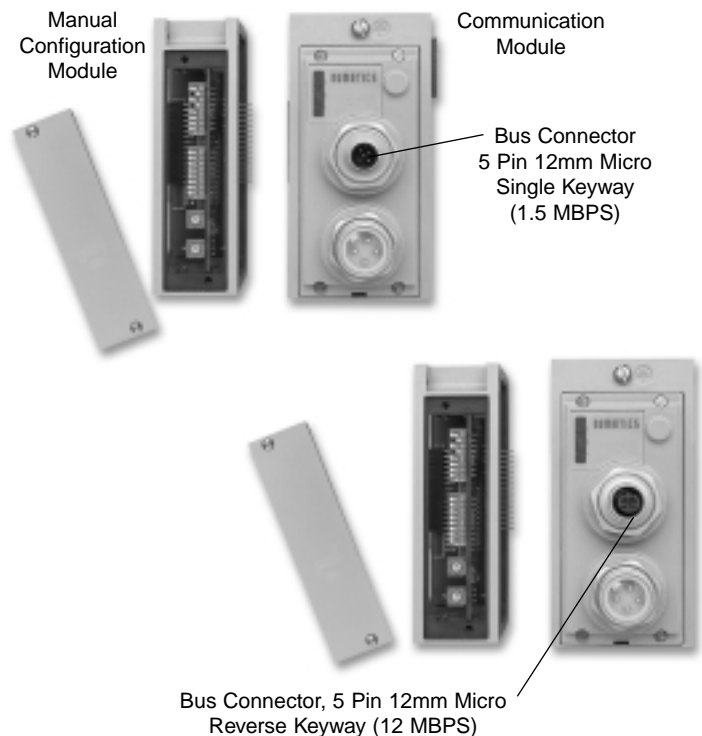

### Technical Data

ELECTRICAL DATA		VOLTAGE	CURRENT
Node Power		24 VDC +/- 10%	0.120 amps.
Valve & Discrete I/O		24 VDC +/- 10%	8 amps. maximum
Aux. Power Connectors	1.5 MBps 12 MBps	Single key way 4 pole 12 mm (Micro) connector Single key way 4 pole 12 mm (Micro) connector	
Communication Connector	1.5 MBps 12 MBps	5 pole 12 mm (Micro) connector 5 pole reverse key female (Micro) connector	
LED's		Processor status, network status, fuse integrity & aux power status	
OPERATING DATA			
Temperature Range		-10° to +115° F (-23° to +46° C)	
Humidity		95% relative humidity, non-condensing	
Moisture		Designed to meet NEMA 4 / IP65 requirements	
CONFIGURATION DATA			
Communication Module		Contains all communication electronics as well as short circuit protected driver circuitry for up to 32 valve solenoids.	
Manual Configuration Module (MCM)		Module containing DIP and rotary switches for setting device configuration data. To order without MCM, use option G20 in NX model number. Optional only when using a Class 2 Profibus DP Master. (Note: see electronic interface options <i>page 27</i> )	
Maximum Valve Solenoid Outputs		32	
Maximum Discrete I/O Points		Manual configurable with MCM (standard): Various combinations of 160 outputs & 96 Inputs Software configurable (optional): Various combination of 192 outputs and 96 inputs	
NETWORK DATA			
Bus Connector		1.5 MBPS: Single keyway 5 pin 12mm micro type (male) 1.5 to 12 MBPS: Single reverse key 5 pin 12mm micro (female)	
Diagnostics		Shorts & open load conditions from valve solenoid coils & discrete outputs are monitored	
Special Features		Supports Class 2 Profibus DP Master with auto-configuration, a fail-safe device	
(GSD) file and technical manuals are available in the download section of the Numatics, Inc. web site at: <a href="http://www.numatics.com/fieldbus">www.numatics.com/fieldbus</a>			





## Discrete I/O Modules

Discrete I/O modules are used to connect additional I/O devices to the valve manifold node. This provides for more efficient use of system resources when configuring a communication system.

### Technical Data

#### ELECTRICAL DATA

Inputs:

Voltage	24 VDC
Type	NPN, PNP or contact closure
LED Indicator	Input status

Outputs:

Voltage	24 VDC +/- 10%
Current	0.5 amperes per output with short circuit protection (consult factory for higher current requirements)
Type	Sinking (NPN) & Sourcing (PNP)
LED Indicator	Output status

#### OPERATING DATA

Temperature Range	-10° to +115° F (-23° to +46° C)
Humidity	95% relative humidity, non-condensing
Moisture	Designed to meet NEMA 4 / IP65 requirements
Connectors	Single key way 4 pin female 12mm micro and 25 & 15 pin Sub-D connectors

#### CONFIGURATION DATA

The physical limitation of the discrete I/O section is 6 modules including the manual configuration module.

	NARROW HOUSING				WIDE HOUSING			
Connectors per Block	4	4	1	2	8	8	1	2
I/O Points per Connector	1	2	16	8	1	2	22	16
Total I/O points	4	8	16	16	8	16	22	32

The maximum number of modules connected to the discrete I/O side is 6. A fully configured manifold assembly would require 6 Wide Profile Modules with double capacity per connector (i.e. 16 I/O points per module times 6 modules equals 96 I/O points). If a Manual Configuration Module is used (standard with A-B 1771 RIO & Profibus-DP), a maximum of five I/O modules may be installed and the maximum number of discrete I/O points is 80.

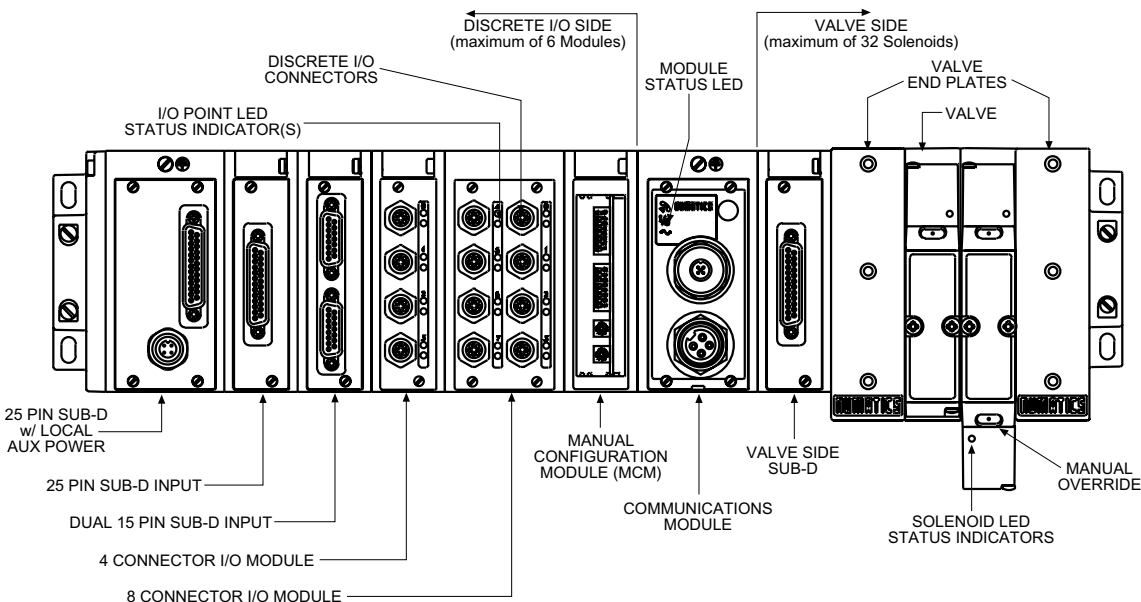



## G2-2 Electronics

### How to Order

#### 1) Assembly Kit Selection

Each valve station must specify valve type and configuration.

**A K C E D 0 0 0 0 3 L STD**

#### Electrical / Electronic Type & Location

- C = Communication Module 2005 & 2012 Series or ISO 15407-2
- E = Communication Module ISO 1, 2 & 3 Series
- V = Communication Module Mark 8, 15 & 55 Series

#### Valve Series

- E = 2005 or ISO 15407-2 18 mm
- G = 2012 or ISO 15407-2 26 mm
- H = Mark 8
- J = Mark 15
- M = Mark 55 Compact
- P = Mark 55 Fullsize
- Q = ISO 5599/2 Size 1
- R = ISO 5599/2 Size 2
- S = ISO 5599/2 Size 3

#### Number of Valve Stations\*

- |       |        |        |        |
|-------|--------|--------|--------|
| A = 1 | I = 9  | Q = 17 | Y = 25 |
| B = 2 | J = 10 | R = 18 | Z = 26 |
| C = 3 | K = 11 | S = 19 | 2 = 27 |
| D = 4 | L = 12 | T = 20 | 3 = 28 |
| E = 5 | M = 13 | U = 21 | 4 = 29 |
| F = 6 | N = 14 | V = 22 | 5 = 30 |
| G = 7 | O = 15 | W = 23 | 6 = 31 |
| H = 8 | P = 16 | X = 24 | 7 = 32 |

#### Options

- STD = Standard
- DRM = DIN Rail Mounting
- MUF = Muffler in End Plates
- DWM = DIN Rail with MUF
- A06 = End plate with ports on left end only, mounting plate only on right end
- D10 = A06 w/DIN Rail Mounting
- D11 = A06 w/Muffler in End Plates
- F05 = A06 w/DIN Rail with MUF
- 14X = External Pilot
- A05 = All Stations Wired as Doubles (AKV only)

#### Port Type

- L = Push In (2005 or 2012 only)
- N = NPTF
- G = Metric

#### End Plate Port Size

- 2 = 2012
- 3 = Same (2012, 2005, Mark 8, ISO 5599/2 Size 1)
- 4 = Used with Mark 15 or ISO 5599/2 Size 2
- 5 = Used with Mark 55 Compact
- 6 = Used with ISO 5599/2 Size 3
- 7 = Used with Mark 55 Fullsize
- H = 2012 (2005 or 2012)
- K = Same (2005 or 2012)

\*Maximum number of valve stations is determined by the combination of single and double Z-Boards types installed in the manifold sub-bases. All G2-2 communication modules support 32 output drivers for valve solenoid coils.

2005	2012	
3 = 3/8	3 = Port Type G, N, or L	
K = 10mm tube	Port 1 = 3/8	Port 3/5 = 1/2
	2 = Port Type L Only	
	Port 1 = 1/4	Port 3/5 = 3/8
	H = Port Type L Only	
	Port 1 = 8mm	Port 3/5 = 12mm
	K = Port Type L Only	
	Port 1 = 10mm	Port 3/5 = 14mm



## How to Order continued

### 2) Fieldbus Electronics

Valve model number with plug-in manifold base (see model selection tables for the valve type).

**N X G DN 16 08 D F E02**

**Fieldbus Protocols**

- AB = Allen Bradley RIO
- CN = ControlNet
- DL = DeviceLogix
- DN = DeviceNet™
- EN = Ethernet
- IS = Interbus-S
- PB = Profibus DP1.5 MBps
- PT = Profibus DP12 MBps

**Number of**

Discrete Inputs (See chart below if in excess of 99)

**Number of**

Discrete Outputs (See chart below if in excess of 99)

**Options**

- E02 = Separate power standard (valve and I/O)
- G08 = With Manual Configuration Module (if not standard) & E02
- G10 = 12mm (Micro) Connector for Communications if Not Standard
- G15 = Required for Mark 8, 15, 55 Series
- G18 = Valve side Sub-D NPN output module
- G20 = Without Manual Configuration Module
- G22 = Dual 15 Pin Sub-D output module
- J03 = G15 plus Manual Configuration Module valve side
- J18 = Dual 25 Pin Sub-D output module valve side

**Voltage**

F = 24 VDC

**I/O Type**

- D = Digital
- A = Analog
- B = Analog and Digital

### 3.) Discrete I/O Table for I/O In Excess of 99

I/O CODE	NUMBER OF I/O	I/O CODE	NUMBER OF I/O	I/O CODE	NUMBER OF I/O	I/O CODE	NUMBER OF I/O
A0	100	B0	110	C0	120	D0	130
A1	101	B1	111	C1	121	D1	131
A2	102	B2	112	C2	122	D2	132
A3	103	B3	113	C3	123		
A4	104	B4	114	C4	124		
A5	105	B5	115	C5	125		
A6	106	B6	116	C6	126		
A7	107	B7	117	C7	127		
A8	108	B8	118	C8	128		
A9	109	B9	119	C9	129		

### 4) Discrete I/O Station Selection (see pages 23-31).



When Ordering:

AKC Manifold Assembly Kit with Fieldbus Electronics  
2005 and 2012 Series and ISO 15407-2 Series

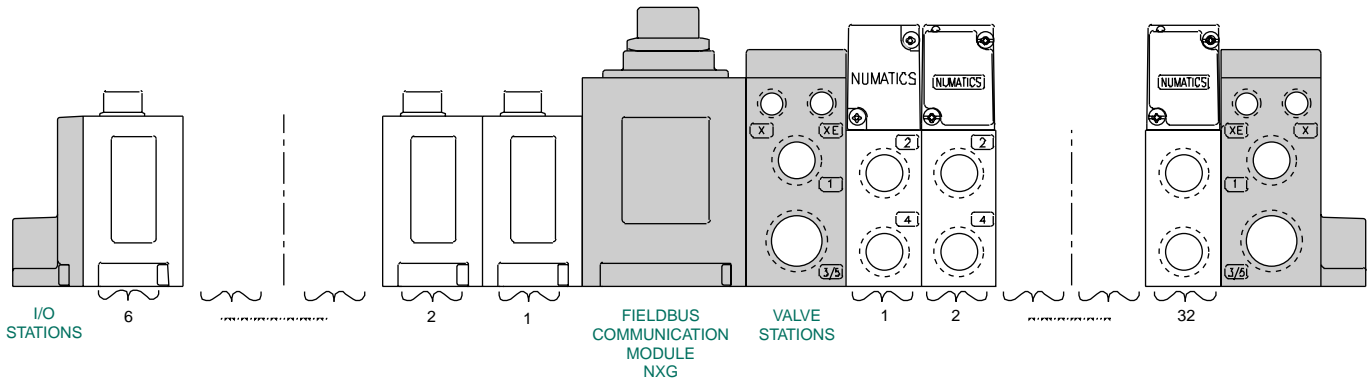

- Shaded components described by Assembly Kit (AK) model number designation (see #1, pg. 22), with the exception of the communication module and number of I/O stations that are described by Electronic Interface (NXG) model number designation. (see #3, pg. 23)
- Each valve manifold station is listed in sequential order from left to right when facing the port side of the manifold as indicated.
- Each discrete I/O station is listed in sequential order from RIGHT to LEFT starting from the communication module as indicated.

NOTE:

1. Total of 32 solenoid outputs available. Either 32 single solenoid valves or 16 double solenoid valves or any combination of singles or doubles, not to exceed 32 solenoid outputs.
2. When ordering a manifold assembly that exceeds 16 solenoids, the model number of the valve station containing the 17<sup>th</sup> solenoid MUST use a selection for the 7<sup>th</sup> and 8<sup>th</sup> digits from the model selection table for the valve type.
3. For manifold assemblies that exceed 16 solenoids, the assembly MUST be configured so an even number of solenoids are utilized prior to the station using the ribbon cable feature. The 16<sup>th</sup> & 17<sup>th</sup> solenoid cannot be on the same valve.

Example Order: (2005)

	AKCEP00003NSTD
valve station 1	051BB4Z2MN00061
valve station 2	051BB4Z2MN00061
valve station 3	051BB4Z2MN00061
valve station 4	051BB4Z2MN00061
valve station 5	051BB4Z2MN00061
valve station 6	051BB4Z2MN00061
valve station 7	051BB4Z2MN00061
valve station 8	051BB4Z2MN00061
valve station 9	051BB4R2MN00061
valve station 10	051BB4Z2MN00061
valve station 11	051BB4Z2MN00061
valve station 12	051BB4Z2MN00061
valve station 13	051BB4Z2MN00061
valve station 14	051BB4Z2MN00061
valve station 15	051BB4Z2MN00061
valve station 16	051BB4Z2MN00061
	NXGDN6438DFE02
I/O station 1	239-1317
I/O station 2	239-1317
I/O station 3	239-1319
I/O station 4	239-1467
I/O station 5	239-1480
I/O station 6	239-1460
	ASSEMBLED



When Ordering:

AKE

ISO 5599/2 Series Manifold Assembly Kit with Fieldbus Electronics

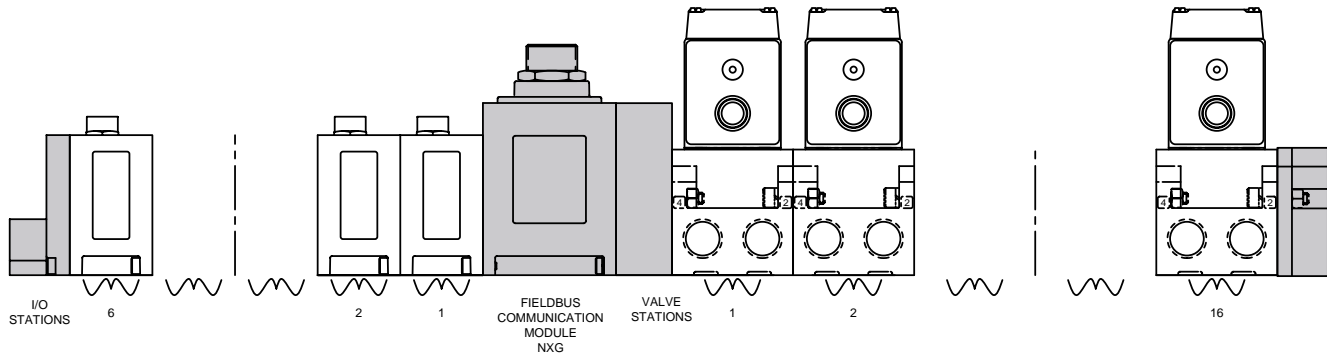

- Shaded components described by assembly Kit (AK) model number designation (see #1, pg. 22), with the exception of the communication module and number of I/O stations that are described by Electronic Interface (NXG) model number designation. (see #3, pg. 23)
- Each valve manifold station is listed in sequential order from left to right when facing the port side of the manifold as indicated.
- Each discrete I/O station is listed in sequential order from RIGHT to LEFT starting from the communication module as indicated.

NOTE:

1. Total of 32 solenoid outputs available. Either 32 single solenoid valves or 16 double solenoid valves or any combination of singles or doubles, not to exceed 32 solenoid outputs.
2. When ordering a manifold assembly that exceeds 16 solenoids, the model number of the valve station containing the 17<sup>th</sup> solenoid MUST use a selection for the 7<sup>th</sup> and 8<sup>th</sup> digits from model selection table for the valve type.
3. For manifold assemblies that exceed 16 solenoids, the assembly MUST be configured so an even number of solenoids are utilized prior to the station using the ribbon cable feature. The 16<sup>th</sup> & 17<sup>th</sup> solenoid cannot be on the same valve.

Example Order:

	AKEQP00003NSTD
valve station 1	I13BB4Z2MN00061
valve station 2	I13BB4Z2MN00061
valve station 3	I13BB4Z2MN00061
valve station 4	I13BB4Z2MN00061
valve station 5	I13BB4Z2MN00061
valve station 6	I13BB4Z2MN00061
valve station 7	I13BB4Z2MN00061
valve station 8	I13BB4Z2MN00061
valve station 9	I13BB4R2MN00061
valve station 10	I13BB4Z2MN00061
valve station 11	I13BB4Z2MN00061
valve station 12	I13BB4Z2MN00061
valve station 13	I13BB4Z2MN00061
valve station 14	I13BB4Z2MN00061
valve station 15	I13BB4Z2MN00061
valve station 16	I13BB4Z2MN00061
	NXGDN6438DFE02
I/O station 1	239-1317
I/O station 2	239-1317
I/O station 3	239-1319
I/O station 4	239-1869
I/O station 5	239-1870
I/O station 6	239-1460
	ASSEMBLED



When Ordering:

AKV Manifold Assembly Kit with Fieldbus Electronics  
Mark 8, 15 and 55 Series

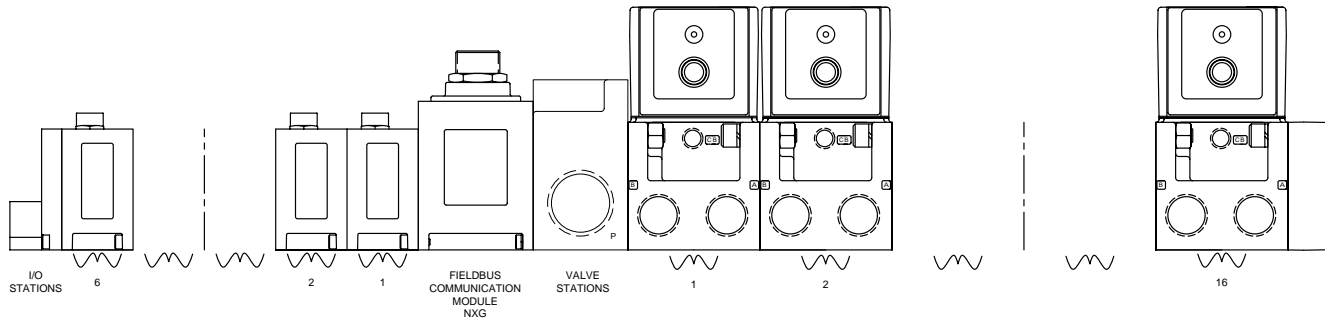

Mark 55 Shown

- Shaded components described by Assembly Kit (AK) model number designation (see #1, pg. 22), with the exception of the communication module and number of I/O stations that are described by Electronic Interface (NXG) model number designation. (see #3, pg. 23)
- Each valve manifold station is listed in sequential order from left to right when facing the port side of the manifold as indicated.
- Each discrete I/O station is listed in sequential order from RIGHT to LEFT starting from the communication module as indicated.

Example Order: (Mark 15)

	AKVJF0004NAØ5
valve station 1	153SS415M019M61
valve station 2	153SA415M019M61
valve station 3	152SA400M000061
valve station 4	153RS115J019M00
valve station 5	153SS425M019M61
valve station 6	153SA425M019M61
valve station 7	153SS515M019M61
	NXGDN3232DFG15
I/O station 1	239-1994
I/O station 2	239-1317
I/O station 3	239-1871
	ASSEMBLED

NOTE:

1. Total of 32 solenoid outputs available. Either 32 single solenoid valves or 16 double solenoid valves or any combination of singles or doubles, not to exceed 32 solenoid outputs.
2. All valves must have a terminal block in the mounting (19M Option).
3. Valves will be wired based on the number of solenoids on the valve (1 output for a single solenoid valve and 2 for double). If all stations are to be wired for double solenoid valves, option code "A05" must be used in the "AK" number.
4. All blank stations will be wired for double solenoid valves.
5. The NX number must use the "G15" option code for combination of.





## Fieldbus Communication Module and Manual Configuration Module Assemblies

### Communication Module Kit

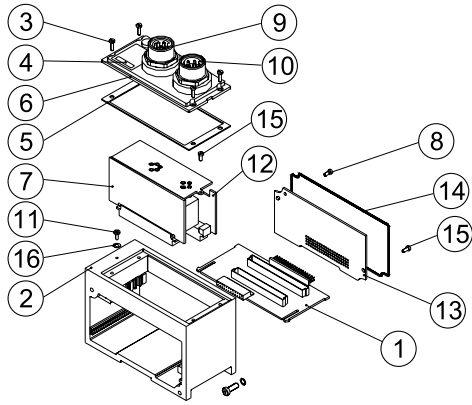

COMMUNICATION MODULE KIT	PART NO.	
	AKC, AKE	AKV
DeviceNet with Mini Comm. Connector (Standard)	239-1514	239-1461
DeviceNet with 12mm Comm. Connector	239-1827	239-1837
Allen-Bradley 1771 RIO with Mini Comm. Connector (Standard)	239-1516	239-1462
Allen-Bradley 1771 RIO with 12mm Comm. Connector	239-1520	239-1839
Profibus-DP (1.5 MBps) with 12mm Comm. Connector	239-1518	239-1463
Profibus-DP (12 MBps) with Reverse Keyway 12mm Comm. Connection	239-1519	239-1620
Interbus-S	239-2117	239-2118
ControlNet	239-1841	239-1842
DeviceLogix	239-2087	Consult Factory
Ethernet	239-2037	Consult Factory

DET. NO.	NO. REQ'D	PART NAME	PART NO.
1	1	Backplane Board Ass'y (AKC, AKE) (AKV)	256-666 256-716
2	1	Housing (not sold separately)	
3	4	Screw	127-852
4	1	Cover Lens	122-1075
5	1	Gasket	113-533
6	1	Cover	105-416
7	1	Comm. Board Ass'y - DeviceNet Comm. Board Ass'y - AB1771-RIO Comm. Board Ass'y - Profibus-DP 1.5 & 12MBps Comm. Board Ass'y - DeviceLogix Comm. Board Ass'y - ControlNet Comm. Board Ass'y - EtherNet	256-673 256-678 256-710 256-849 256-789 256-848
8 *	1	Screw	127-794
9	1	5 Pin "Mini" Conn. - DeviceNet & AB 1771-RIO 5 Pin Conn. - Profibus DP 1.5MBps 5 Pin 12mm male - DeviceNet & AB 1771 RIO 5 Pin 12mm reverse key - Profibus DP 12MBPS	140-810 140-847 140-847 140-848
10	1	4 Pin Conn.	140-809
11	1	Ground Screw	127-176
12	1	Driver Board Ass'y	256-680
13 *	1	Converter Board Ass'y	256-671
14	2	Gasket	113-531
15 *	2	Ground Screw	127-318
16	1	Washer	128-162
	1	Valve & Output Fuse (10A)	140-934
	1	Node Input Fuse (4A)	140-933

\*Not used with AKV kits.

### Manual Configuration Module (MCM) Kit (For All Protocols)

239-1384

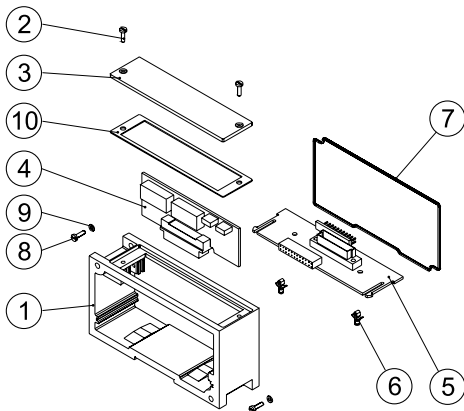

DET. NO.	NO. REQ'D	PART NAME	PART NO.
1	1	Housing (not sold separately)	
2	2	Screw	127-852
3	1	Cover	105-418
4	1	Switch Board Assembly	256-684
5	1	Switch Backplane	256-672
6	2	Support Pin	140-828
7	2	Gasket	113-531
8	2	Screw	127-697
9	2	Lockwasher	128-188
10	1	Gasket	113-532



## G2-2 Electronics

### I/O Block Assemblies

#### Input/Output Module Kit 4/8

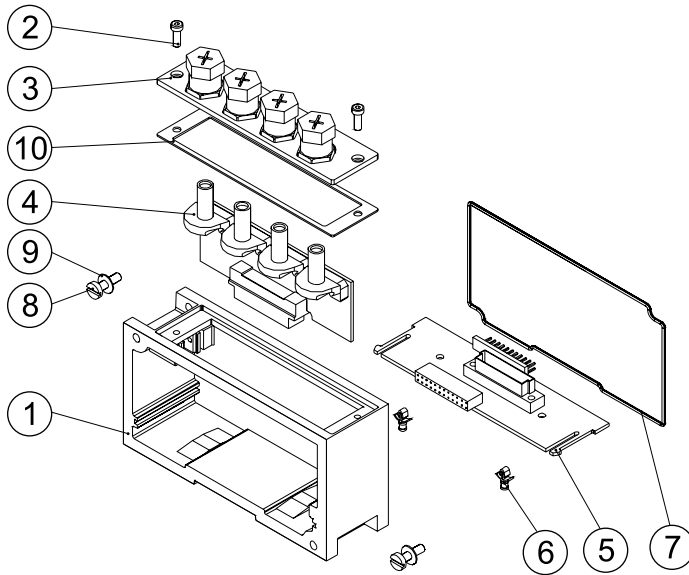

DET. NO.	NO. REQ'D	PART NAME	PART NO.
1	1	Housing (not sold separately)	
2	2	Screw	127-852
3	1	I/O Cover Assembly 4 I/O Points	205-377
	1	I/O Cover Assembly 8 I/O Points	205-378
4	1	I/O Board Ass'y	See Chart Below
5	1	I/O Backplane	256-672
6	2	Support Pin	140-828
7	1	Gasket	113-531
8	2	Screw	127-697
9	2	Lockwasher	128-188
10	1	Gasket	113-532
	1	I/O Connector Dust Cover	230-647

	4 INPUTS	4 OUTPUTS	8 INPUTS	8 OUTPUTS
Sinking (NPN)	239-1304	239-1306*	239-1308	239-1310*
Replacement I/O Board for above	256-646	256-650	256-647	256-651
Sourcing (PNP)	239-1305	239-1307	239-1309	239-1311
Replacement I/O Board for above	256-648	256-652	256-649	256-653

#### Input/Output Module Kit 8/16

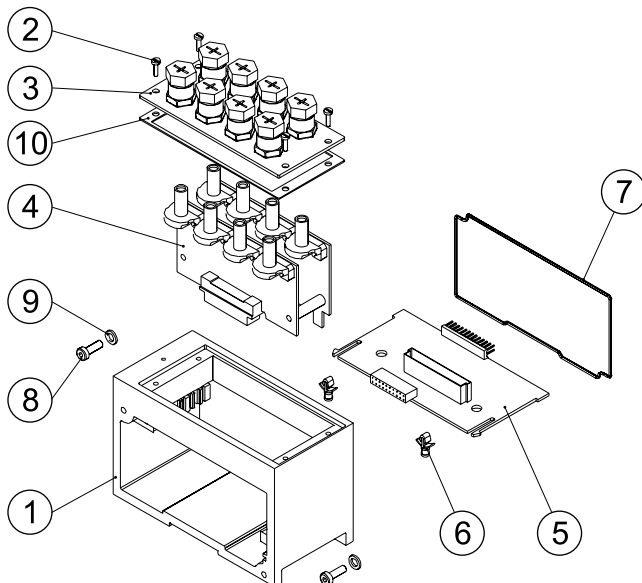

DET. NO.	NO. REQ'D	PART NAME	PART NO.
1	1	Housing (not sold separately)	
2	2	Screw	127-852
3	1	I/O Cover Assembly 8 I/O Points	205-381
	1	I/O Cover Assembly 16 I/O Points	205-382
4	1	I/O Board Ass'y	See Chart Below
5	1	I/O Backplane	256-665
6	2	Support Pin	140-828
7	1	Gasket	113-531
8	2	Screw	127-697
9	2	Lockwasher	128-188
10	1	Gasket	113-533
	1	I/O Connector Dust Cover	230-647

	8 INPUTS	8 OUTPUTS	16 INPUTS	16 OUTPUTS
Sinking (NPN)	239-1312	239-1314*	239-1316	239-1318*
Replacement I/O Board for above	256-654	256-658	256-655	256-659
Sourcing (PNP)	239-1313	239-1315	239-1317	239-1319
Replacement I/O Board for above	256-656	256-660	256-657	256-661

\*Not to be used for new applications. Replacement units only.



## 25 Pin Sub-D Connector Input

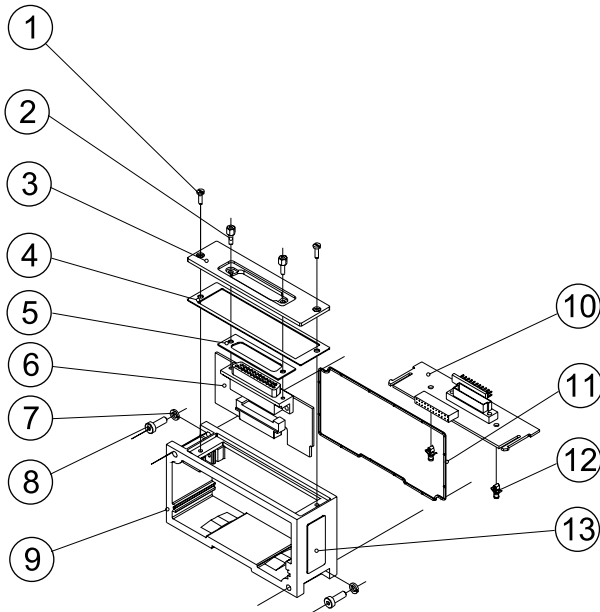

DET. NO.	NO. REQ'D	PART NAME	PART NO.
1	2	Screw	127-852
2	4	Hex Screw	127-825
3	1	Cover	105-427
4	1	Gasket	113-532
5	2	Gasket	113-507
6	1	Input Module Board Ass'y (Sinking NPN)	256-797
6	1	Input Module Board Ass'y (Sourcing PNP)	256-799
7	2	Lockwasher	128-188
8	2	Screw	127-697
9	1	Housing (not sold separately)	
10	1	I/O Backplane Board Ass'y	256-672
11	1	Gasket	113-531
12	2	Support Pin	140-828
13	2	Nameplate	122-1057

25 PIN SUB-D INPUT KITS	PART NO.
16 Point Sinking (NPN)	239-1869
16 Point Sourcing (PNP)	239-1871

## Dual 15 Pin Sub-D Connector Input

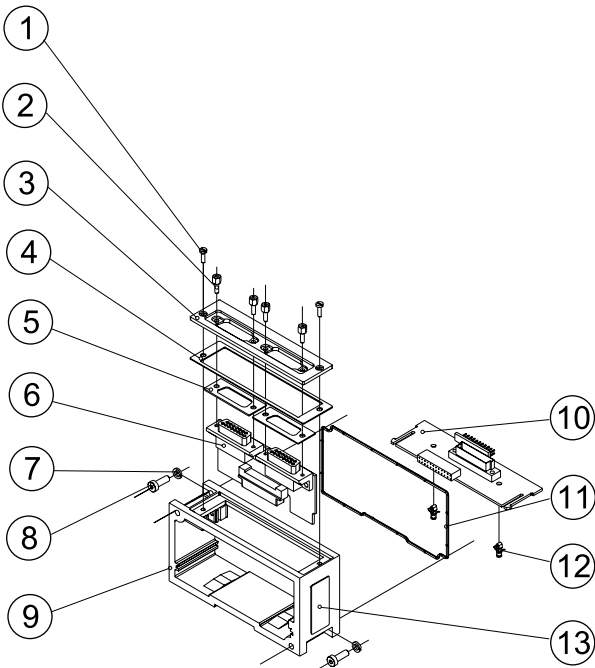

DET. NO.	NO. REQ'D	PART NAME	PART NO.
1	2	Screw	127-852
2	4	Hex Screw	127-825
3	1	Cover	105-426
4	1	Gasket	113-532
5	2	Gasket	113-566
6	1	Input Module Board Ass'y (Sinking NPN)	256-796
6	1	Input Module Board Ass'y (Sourcing PNP)	256-798
7	2	Lockwasher	128-188
8	2	Screw	127-697
9	1	Housing (not sold separately)	
10	1	I/O Backplane Board Ass'y	256-672
11	1	Gasket	113-531
12	2	Support Pin	140-828
13	2	Nameplate	122-1057

DUAL 15 PIN SUB-D INPUT KITS	PART NO.
16 Point Sinking (NPN)	239-1868
16 Point Sourcing (PNP)	239-1870



25 Pin Sub-D Connector Output Module w/Aux. Power Connector  
(22 Outputs)

239-1460

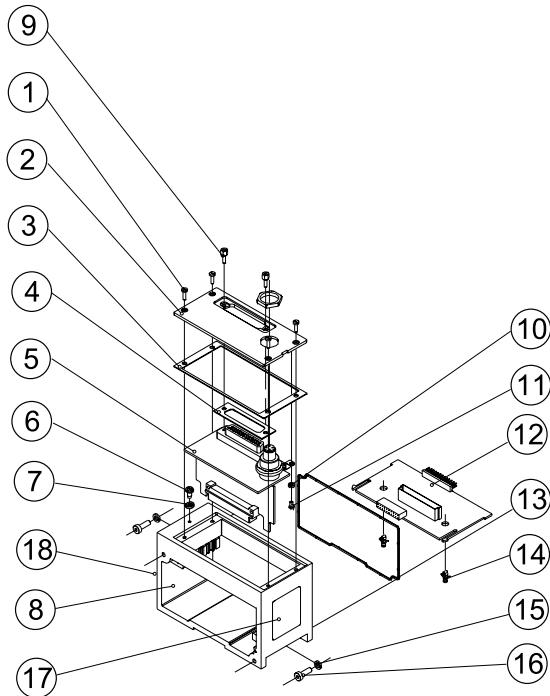

DET. NO.	NO. REQ'D	PART NAME	PART NO.
1	4	Screw	127-852
2	1	Cover	105-425
3	1	Gasket	113-533
4	1	Gasket	113-507
5	1	Output Board Ass'y	256-722
6	1	Screw	127-176
7	1	Washer	128-162
8	1	Housing (not sold separately)	
9	2	Jack Screw	127-825
10	1	Washer	128-350
11	1	Screw	127-172
12	1	I/O Backplane Board Ass'y	256-665
13	1	Gasket	113-531
14	2	Support Pin	140-828
15	2	Lockwasher	128-188
16	1	Screw	127-697
17	1	Nameplate	122-1058
18	1	Nameplate	122-1057
	1	Replacement Fuse (4A)	140-933

Dual 25 Pin Sub-D Connector Output Module  
with Aux. Power Connector  
(32 Outputs)

239-1994

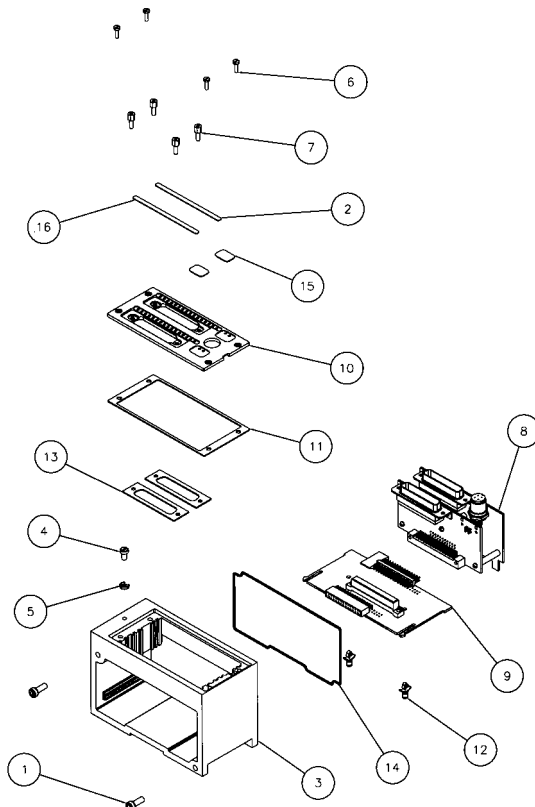

DET. NO.	NO. REQ'D	PART NAME	PART NO.
1	2	Screw	127-697
2	1	Cover Lens	122-1153
3	1	Housing	125-802
4	1	Ground Screw	127-176
5	1	Cup Washer	128-162
6	4	Screw	127-852
7	4	Jack Screw	127-825
8	1	Dual Sub-D Output Board	256-825
9	1	Backplane Board Assembly	256-665
10	1	Cover	105-448
11	1	Gasket	113-533
12	2	Support Pin	140-828
13	2	Gasket	113-507
14	1	Gasket	113-531
15	2	Lens	122-1180
16	1	Cover Lens	122-1156
	2	Replacement Fuse (4A)	140-933



## Valve Side Sub-D Output Modules Dual 25 Pin Sub-D Output Module

239-1867

- Used without valves only
- Located between communication module and right mounting cover
- Provides 32 output capability 16 outputs per connector.

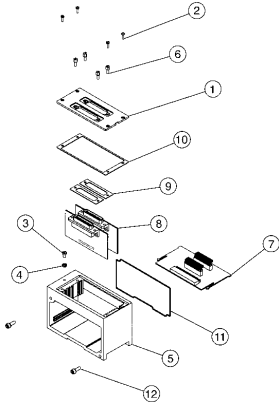

DET. NO.	NO. REQ'D	PART NAME	PART NO.
1	1	Cover, Dual Sub-D	105-445
2	4	Screw	127-852
3	1	Ground Screw	127-176
4	1	Cup Washer	128-162
5	1	Housing	125-802
6	4	Jack Screw	127-825
7	1	Backplane, Dual Sub-D	256-794
8	2	Connector Board	256-795
9	2	Gasket, 25 Pin Sub-D	113-507
10	1	Gasket, Cover	113-533
11	1	Gasket, Housing	113-531
12	2	Screw Assembly	127-396

## Single 25 Pin Sub-D Output Module

239-1713

- Used to connect auxiliary valve manifold when main manifold utilizes 16 solenoids output or less.
- Picks up solenoid outputs 17-32.

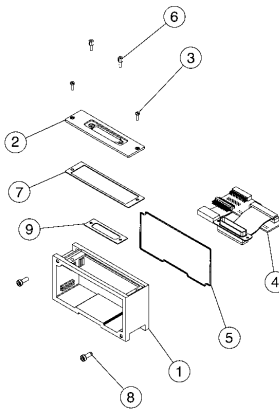

DET. NO.	NO. REQ'D	PART NAME	PART NO.
1	1	Housing	125-801
2	1	Cover	105-427
3	2	Screw	127-852
4	1	P.C. Board Assembly	256-741
5	1	Gasket	113-531
6	2	Jack Screw	127-825
7	1	Gasket	113-532
8	2	Screw	127-697
9	1	Gasket	113-507

## Dual 15 Pin Sub-D Output Module

239-2041

- Use with cable on *page 42* to connect with standard 25 Pin Sub-D Manifold with 8 coils or less.
- 8 outputs per connector.

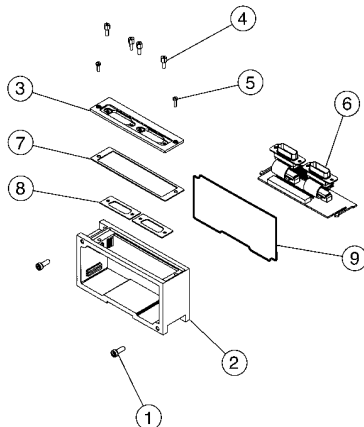

DET. NO.	NO. REQ'D	PART NAME	PART NO.
1	2	Screw	127-697
2	1	Housing	125-801
3	1	Cover	105-426
4	4	Jack Screw	127-825
5	2	Screw	127-852
6	1	Dual 15 Pin Sub-D Board Assembly	256-847
7	1	Gasket	113-532
8	2	Gasket	113-566
9	1	Gasket	113-531



## G2-2 Electronics

### Left Mounting Cover Assembly

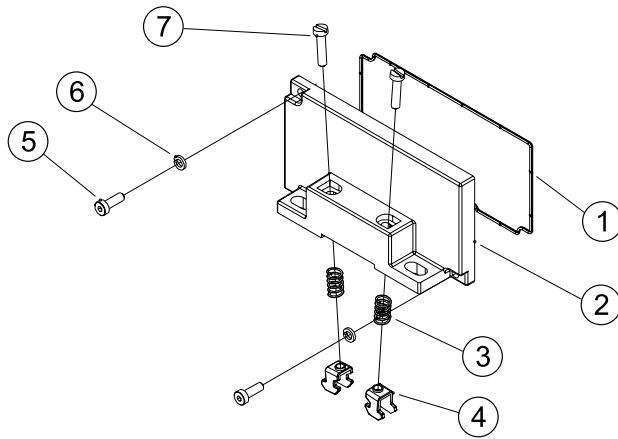

DET. NO.	NO. REQ'D	PART NAME	PART NO.
1	1	Gasket	113-531
2	1	Mounting Cover	105-403
3	2	Spring (DIN Rail Only)	115-355
4	2	Clamp (DIN Rail Only)	125-720
5	2	Screw	127-697
6	2	Lockwasher	128-188
7	2	Screw (DIN Rail Only)	127-472

LEFT HAND MOUNTING COVER ASSEMBLY	PART NO.
Without DIN	239-1816
With DIN	239-1815

### Right Mounting Cover Assembly

Use Only with Dual 25 Pin Valve Side Output Module

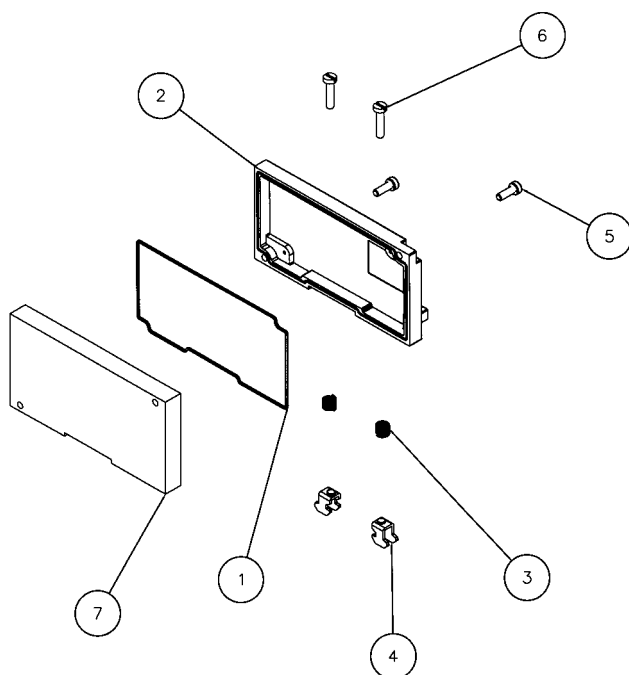

DET. NO.	NO. REQ'D	PART NAME	PART NO.
1	1	Gasket	113-531
2	1	Mounting Cover	105-403
3	2	Spring (DIN Rail Only)	115-355
4	2	Clamp (DIN Rail Only)	125-720
5	2	Screw	127-697
6	2	Screw (DIN Rail Only)	127-472
7	1	Adaptor Plate	119-734

RIGHT HAND MOUNTING COVER ASSEMBLY	PART NO.
Without DIN	239-1873
With DIN	239-1872





## Dimensional Drawing G2-2 Fieldbus Communication Assembly

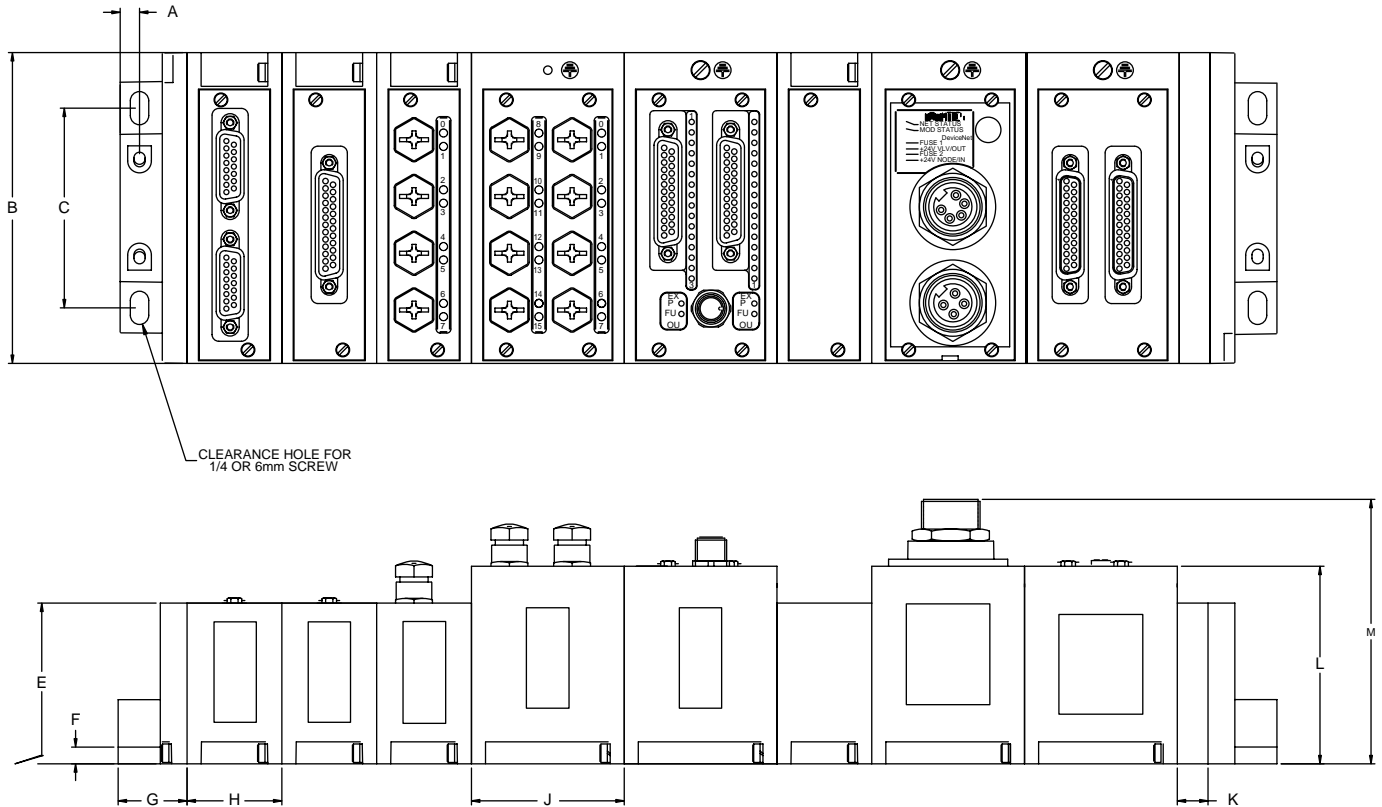

### Dimensions

top dimensions = inches  
bottom dimensions (in parenthesis) = millimeters

A	B	C	E	F	G	H	J	K	L	M
0.29 (7.4)	4.65 (118.1)	2.98 (75.7)	2.40 (61.0)	1.00 (25.4)	1.00 (25.4)	1.42 (36.1)	2.28 (57.9)	0.46 (11.7)	2.95 (74.9)	3.95 (100.3)



## 4 Pole Mini Power Cables for G2-2 Electronics

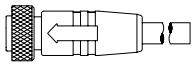

### FEMALE 4 POLE STRAIGHT 18 AWG EURO COLOR CODE

- 1 Meter - MC0401MAF0000000
- 2 Meter - MC0402MAF0000000
- 5 Meter - MC0405MAF0000000

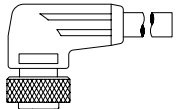

### FEMALE 4 POLE 90° 18 AWG EURO COLOR CODE

- 1 Meter - MD0401MAF0000000
- 2 Meter - MD0402MAF0000000
- 5 Meter - MD0405MAF0000000

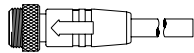
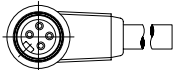

### MALE 4 POLE STRAIGHT 18 AWG EURO COLOR CODE

- 1 Meter - MA0401MAF0000000
- 2 Meter - MA0402MAF0000000
- 5 Meter - MA0405MAF0000000

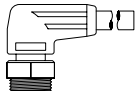

### MALE 4 POLE 90° 18 AWG EURO COLOR CODE

- 1 Meter - MB0401MAF0000000
- 2 Meter - MB0402MAF0000000
- 5 Meter - MB0405MAF0000000

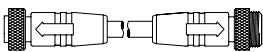
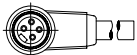

### F/M 4 POLE STRAIGHT 18 AWG EURO COLOR CODE

- 1 Meter - MC0401MAFMA04000
- 2 Meter - MC0402MAFMA04000
- 5 Meter - MC0405MAFMA04000

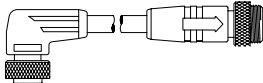

### F 90/M STRAIGHT 18 AWG EURO COLOR CODE

- 1 Meter - MD0401MAFMA04000
- 2 Meter - MD0402MAFMA04000
- 5 Meter - MD0405MAFMA04000

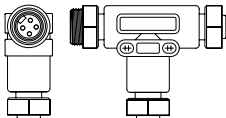

### 4 POLE "T"

MC0400000MT04000

### 4 Pole Pin-Out

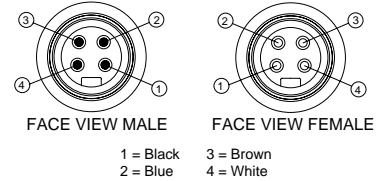

### TECHNICAL DATA

Molded Body / Insert	PUR
Coupling Nut	Aluminum
Cable	PVC
Cable O.D.	0.290"
Voltage Rating	300 V
Amperage	5.6 A
Protection	IP 68, NEMA 6P
Operating Temperature	-40°C to 90°C



## Field Attachable Connectors 3, 4, and 5 Pole

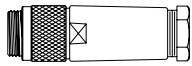

### 4 POLE MINI MALE STRAIGHT

PG 9 Cable Gland - MA04F20000000000

PG 13.5 Cable Gland - MA04F300000000000

### 5 POLE MINI MALE STRAIGHT

PG 9 Cable Gland - MA05F200000000000

PG 13.5 Cable Gland - MA05F300000000000

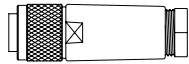

### 4 POLE MINI FEMALE STRAIGHT

PG 9 Cable Gland - MC04F200000000000

PG 13.5 Cable Gland - MC04F300000000000

### 5 POLE MINI FEMALE STRAIGHT

PG 9 Cable Gland - MC05F200000000000

PG 13.5 Cable Gland - MC05F300000000000

### 5 POLE MINI FEMALE STRAIGHT FOR RIO COMMUNICATION

PG 13.5 Cable Gland - MC05M200000000000

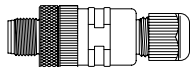

### 4 POLE MICRO MALE STRAIGHT

PG 7 Cable Gland - TA04F100000000000

PG 9 Cable Gland - TA04F200000000000

### 5 POLE MICRO MALE STRAIGHT

PG 7 Cable Gland - TA05F100000000000

PG 9 Cable Gland - TA05F200000000000

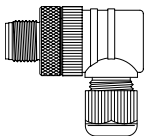

### 4 POLE MICRO MALE 90 DEGREE

PG 7 Cable Gland - TB04F100000000000

PG 9 Cable Gland - TB04F200000000000

### 5 POLE MICRO MALE 90 DEGREE

PG 7 Cable Gland - TB05F100000000000

PG 9 Cable Gland - TB05F200000000000

### TECHNICAL DATA - Mini

Molded Body / Insert	Glass Filled Nylon/Nylon
Coupling Nut	Aluminum
Cable Range	PG9: 0.157-0.315 PG13.5: 0.394-0.472
Voltage Rating	600 V
Amperage	4 Pole - 9 A 5 Pole - 9 A
Protection	IP 67, NEMA 6P
Operating Temperature	-40°C to 90°C

### 4 Pole Pin-Out

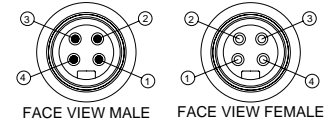

### 5 Pole Pin-Out

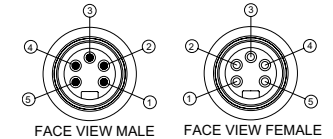

### Micro 4 Pole Pin-Out

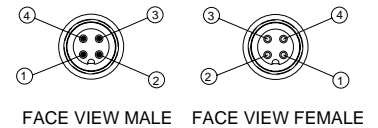

### Micro 5 Pole Pin-Out

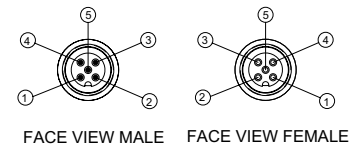



## G2-2 Electronics

### Field Attachable Connectors 3, 4, and 5 Pole continued

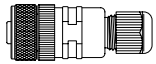

#### 4 POLE MICRO FEMALE STRAIGHT

PG 7 Cable Gland - TC04F10000000000

PG 9 Cable Gland - TC04F20000000000

#### 5 POLE MICRO FEMALE STRAIGHT

PG 7 Cable Gland - TC05F10000000000

PG 9 Cable Gland - TC05F20000000000

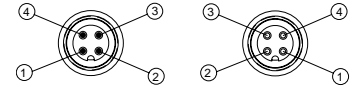

FACE VIEW MALE    FACE VIEW FEMALE

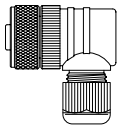

#### 4 POLE MICRO FEMALE 90 DEGREE

PG 7 Cable Gland - TD04F10000000000

PG 9 Cable Gland - TD04F20000000000

#### 5 POLE MICRO FEMALE 90 DEGREE

PG 7 Cable Gland - TD05F10000000000

PG 9 Cable Gland - TD05F20000000000

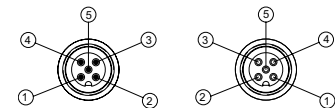

FACE VIEW MALE    FACE VIEW FEMALE

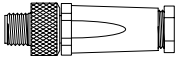

#### 3 POLE PICO MALE STRAIGHT

Cable Dia. 0.138 to 0.197 - PA03F00000000000

#### 4 POLE PICO MALE STRAIGHT

Cable Dia. 0.138 to 0.197 - PA04F00000000000

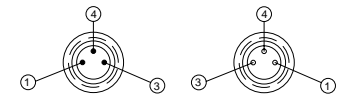

FACE VIEW MALE    FACE VIEW FEMALE

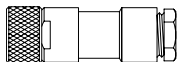

#### 3 POLE PICO FEMALE STRAIGHT

Cable Dia. 0.138 to 0.197 - PC03F000000000000

#### 4 POLE PICO FEMALE STRAIGHT

Cable Dia. 0.138 to 0.197 - PC04F00000000000

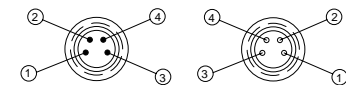

FACE VIEW MALE    FACE VIEW FEMALE

#### TECHNICAL DATA - Micro 12 mm / Pico 8 mm

12 mm Molded Body    Nylon

8 mm Molded Body    TPU

Insert    Nylon

Coupling Nut    12 mm Brass, Nickel Plated, 8 m CuZn, brass, nickeled

Cable Range    PG7: 0.119 - 0.255    PG9: 0.157 - 0.315

Pico 8 mm: 0.138 - 0.197

Voltage Rating    12 mm: 250 V    8 mm: 60 VAC/75 VDC

Amperage    4.0 A

Protection    IP 67, NEMA 6 (12 mm only)

Operating Temp    -25°C to 85°C



## Profibus Cables and Accessories (Reverse Key)

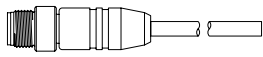

### MALE 12MM REVERSE KEY SINGLE ENDED

- 1 Meter - RA0501MHP0000000
- 2 Meter - RA0502MHP0000000
- 5 Meter - RA0505MHP0000000

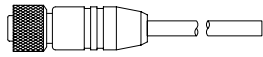

### FEMALE 12MM REVERSE KEY SINGLE ENDED

- 1 Meter - RC0501MHP0000000
- 2 Meter - RC0502MHP0000000
- 5 Meter - RC0505MHP0000000

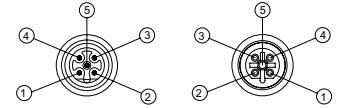

FACE VIEW MALE      FACE VIEW FEMALE

- 1 = N/C      2 = Green
- 3 = N/C      3 = Red
- 5 = Shield

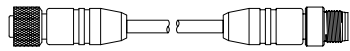

### F/M 12MM REVERSE KEY DOUBLE ENDED

- 1 Meter - RC0501MHPRA05000
- 2 Meter - RC0502MHPRA05000
- 5 Meter - RC0505MHPRA05000

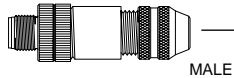

### FIELD INSTALLABLE CONNECTORS

Male - RA05F200P0000000

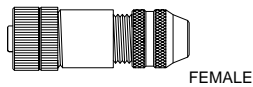

Female - RC05F200P0000000

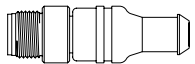

### TERMINATING RESISTORS

Male - RA050000P0000000

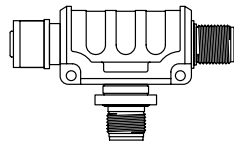

### BUS "T"

RA050000PRT05000

### TECHNICAL DATA

Molded Body / Insert	Cable=PUR, Field Attachable=PA
Coupling Nut	Nickel Plated
Cable	PUR
Voltage Rating	Cable=250 V, Field Attachable=30 VAC/36 VDC
Amperage	Field Attachable=4.0 A
Protection	Cable=IP67/68/NEMA 6P, Field Attachable=IP67
Operating Temperature	-40°C to 80°C Static, -5° to 80°C Moving



## 4 Pole Micro Power Cables for G2-1 Electronics

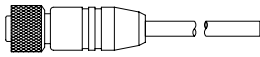

### FEMALE 4 POLE STRAIGHT 18 AWG EURO COLOR CODE

- 1 Meter - TC0401MAE0000000
- 2 Meter - TC0402MAE0000000
- 5 Meter - TC0405MAE0000000

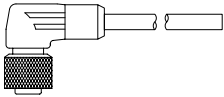

### FEMALE 4 POLE 90° 18 AWG EURO COLOR CODE

- 1 Meter - TD0401MAE0000000
- 2 Meter - TD0402MAE0000000
- 5 Meter - TD0405MAE0000000

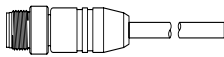

### MALE 4 POLE STRAIGHT 18 AWG EURO COLOR CODE

- 1 Meter - TA0401MAE0000000
- 2 Meter - TA0402MAE0000000
- 5 Meter - TA0405MAE0000000

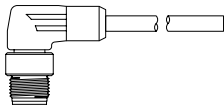

### MALE 4 POLE 90° 18 AWG EURO COLOR CODE

- 1 Meter - TB0401MAE0000000
- 2 Meter - TB0402MAE0000000
- 5 Meter - TB0405MAE0000000

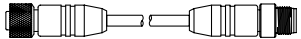

### F/M 4 POLE STRAIGHT 18 AWG EURO COLOR CODE

- 1 Meter - TC0401MAETA04000
- 2 Meter - TC0402MAETA04000
- 5 Meter - TC0405MAETA04000

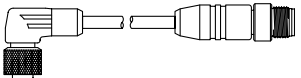

### F 90/M STRAIGHT 18 AWG EURO COLOR CODE

- 1 Meter - TD0401MAETA04000
- 2 Meter - TD0402MAETA04000
- 5 Meter - TD0405MAETA04000

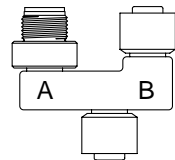

### 4/5 POLE "T" (POWER)

TC0500000TT05000

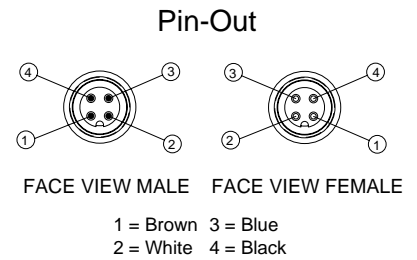

### TECHNICAL DATA

Molded Body / Insert	PUR
Coupling Nut	"T" - Aluminum
	Cables - Brass, Nickel Plated
Cable	PUR
Cable O.D.	0.190"
Voltage Rating	250 V
Amperage	4.0 A
Protection	IP 68, NEMA 6P
Operating Temperature	-40°C to 90°C





## DeviceNet Trunk Cables, Drop Cables and Accessories

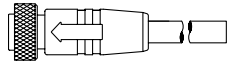

### FEMALE MINI THICK CABLE

3 Foot - MC0503FFD0000000

6 Foot - MC0506FFD0000000

12 Foot - MC0512FFD0000000

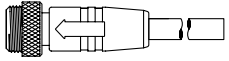

### MALE MINI THICK CABLE

3 Foot - MA0503FFD0000000

6 Foot - MA0506FFD0000000

12 Foot - MA0512FFD0000000



### FEMALE TO MALE MINI THICK CABLE EXTENSION

3 Foot - MC0503FFDMA05000

6 Foot - MC0506FFDMA05000

12 Foot - MC0512FFDMA05000

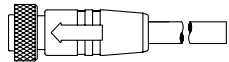

### FEMALE MINI THIN CABLE

3 Foot - MC0503FGD0000000

6 Foot - MC0506FGD0000000

12 Foot - MC0512FGD0000000

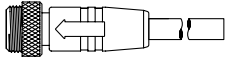

### MALE MINI THIN CABLE

3 Foot - MA0503FGD0000000

6 Foot - MA0506FGD0000000

12 Foot - MA0512FGD0000000



### FEMALE TO MALE MINI THIN CABLE EXTENSION

3 Foot - MC0503FGDMA05000

6 Foot - MC0506FGDMA05000

12 Foot - MC0512FGDMA05000

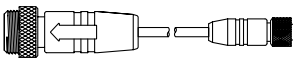

### MALE MINI/FEMALE MICRO DROP THIN CABLE EXT.

3 Foot - MA0503FGDTC05000

6 Foot - MA0506FGDTC05000

10 Foot - MA0512FGDTC05000

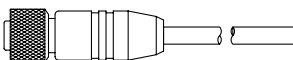

### FEMALE MICRO THIN CABLE

3 Foot - TC0503FGD0000000

6 Foot - TC0506FGD0000000

12 Foot - TC0512FGD0000000

### Mini

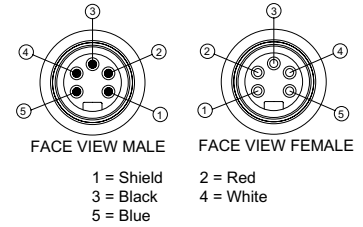



DeviceNet Trunk Cables, Drop Cables and Accessories continued

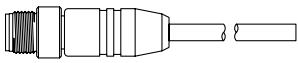

**MALE MICRO THIN CABLE**

- 3 Foot - MC0503FFD0000000
- 6 Foot - MC0506FFD0000000
- 12 Foot - MC0512FFD0000000

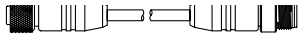

**FEMALE/MALE MICRO THIN CABLE EXTENSION**

- 3 Foot - MA0503FFD0000000
- 6 Foot - MA0506FFD0000000
- 12 Foot - MA0512FFD0000000

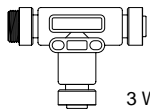

3 WAY MINI "T"

**DEVICENET T'S**

- 3 Way Mini "T" - MC0500000MT05000
- 3 Way Mini - Micro "T" - TC0500000MT05000
- 3 Way Micro "T" - TC0500000TT05000

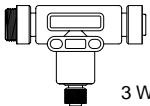

3 WAY MINI / MICRO "T"

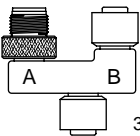

3 WAY MICRO "T"

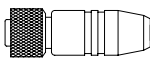

MICRO FEMALE

**TERMINATING RESISTORS**

- Micro Female - TC05000000000000
- Micro Male - TA05000000000000
- Mini Female - MC05000000000000
- Mini Male - MA05000000000000

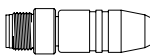

MICRO MALE

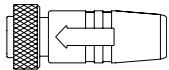

MINI FEMALE

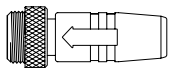

MINI MALE

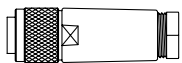

**FEMALE MINI FIELD ATTACHABLE**

- PG 9 Cable Gland - MC05F200D0000000
- PG 13.5 Cable Gland - MC05F300D0000000

NOTE: Color coded for DeviceNet.

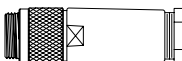

**MALE MINI FIELD ATTACHABLE**

- PG 9 Cable Gland - MA05F200D0000000
- PG 13.5 Cable Gland - MA05F300D0000000

Micro

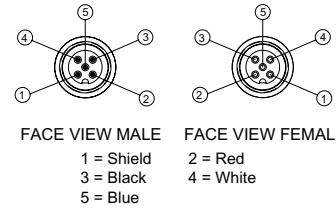



DeviceNet Trunk Cables, Drop Cables and Accessories continued

TECHNICAL DATA		
Molded Body / Insert	PUR	
Coupling Nut	Mini - Aluminum	
	Micro - Nickel Plated Brass	
Cable	PVC	
Cable O.D.	Thick - 0.475"	Thin - 0.275"
Voltage Rating	Mini - 300 V	Micro - 150 V
Amperage	Thick - 8.0 A	Thin - 2.4 A
Protection	IP 68, NEMA 6P	
Operating Temperature	-20°C to 90°C	

12 and 26 Pole Cables and Connectors

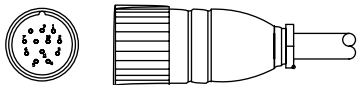

12 POLE ROUND FEMALE CABLE 20 AWG - UNSHIELDED

- Connector with Crimp Contacts - 230-879
- Connector with Solder Cups - 230-960
- 2 Meter - CC1202MB00000000
- 5 Meter - CC1205MB00000000
- 10 Meter - CC1210MB00000000

Pin-Out

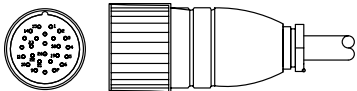
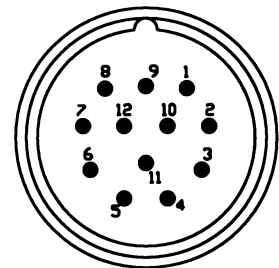

26 POLE ROUND FEMALE CABLE 20 AWG - UNSHIELDED

- Connector with Crimp Contacts - 230-742
- Connector with Solder Cups - 230-1070
- 2 Meter - CC2602MB00000000
- 5 Meter - CC2605MB00000000
- 10 Meter - CC2610MB00000000

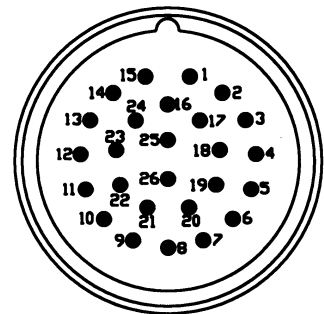

TECHNICAL DATA

Connector Body	Nickel Plated, Copper Alloy	
Insert	Thermoplastic	
Cable	PVC	
Cable O.D.	Thick - 0.475"	Thin - 0.275"
Voltage Rating	300 V	
Amperage	4.0 A / Conductor	
Protection	IP 67	
Operating Temperature	-40°C to 70°C	

NOTE: Cable does not have color identification; each conductor is numbered the length of the cable.



## Sub-D Cables

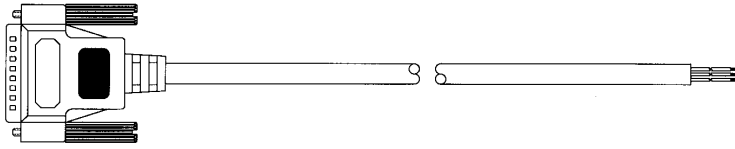

### 25 PIN SUB-D MALE CABLE 22 AWG - UNSHIELDED

- 2 Meter - SA2502MCX0000000
- 5 Meter - SA2505MCX0000000
- 10 Meter - SA2510MCX0000000

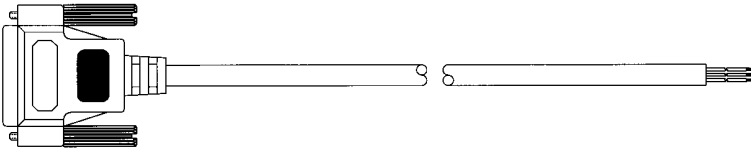

### 25 PIN SUB-D FEMALE CABLE 22 AWG - UNSHIELDED

- 2 Meter - SC2502MCX0000000
- 5 Meter - SC2505MCX0000000
- 10 Meter - SC2510MCX0000000

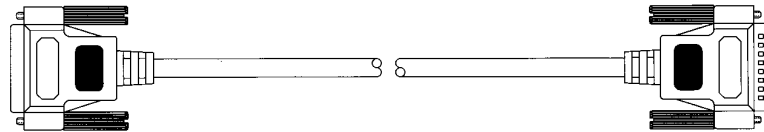

### 25 PIN SUB-D MALE/FEMALE CABLE 22 AWG - UNSHIELDED

- 2 Meter - SA2502MCXSC25000
- 5 Meter - SA2505MCXSC25000
- 10 Meter - SA2510MCXSC25000

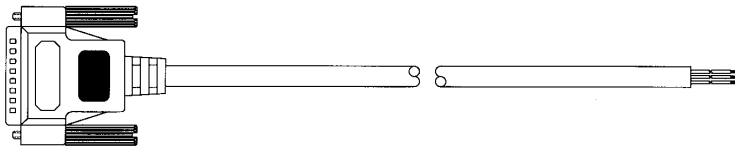

### 25 PIN SUB-D MALE CABLE 24 AWG - SHIELDED

- 2 Meter - SA2502MDX0000000
- 5 Meter - SA2505MDX0000000
- 10 Meter - SA2510MDX0000000

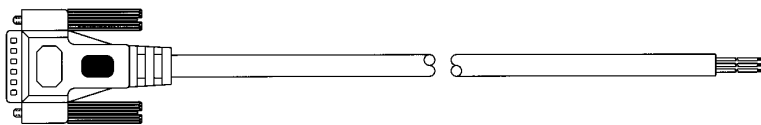

### 15 PIN SUB-D MALE CABLE 24 AWG - SHIELDED

- 2 Meter - SA1502MDX0000000
- 5 Meter - SA1505MDX0000000
- 10 Meter - SA1510MDX0000000

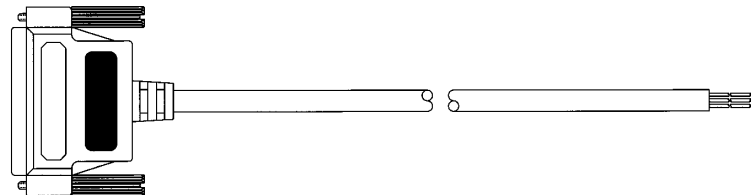

### 37 PIN SUB-D FEMALE CABLE 22 AWG - UNSHIELDED

- 2 Meter - SC3702MCX0000000
- 5 Meter - SC3705MCX0000000
- 10 Meter - SC3710MCX0000000

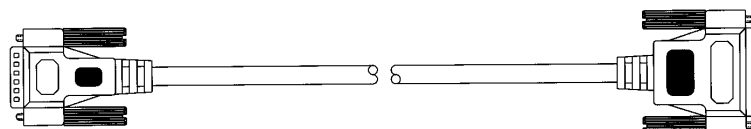

### 15 PIN MALE/25 PIN FEMALE SUB-D CABLE 22 AWG - UNSHIELDED

- 2 Meter - SA1502MCXSC25000
- 5 Meter - SA1505MCXSC25000
- 10 Meter - SA1510MCXSC25000



Sub-D Cables continued

25 Pin-Out

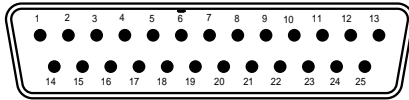

15 Pin-Out

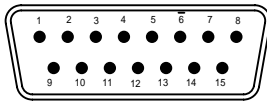

37 Pin-Out

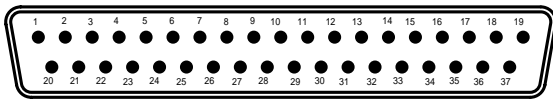

15 to 25 Pin-Out

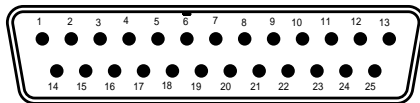
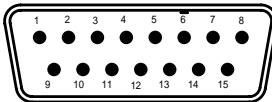

TECHNICAL DATA

Connector Body	PVC
Cable	PVC
Cable O.D.	37 Conductor, 22 AWG - N/A
	25 Conductor, 22 AWG - 0.394"
	25 Conductor, 24 AWG - 0.335"
	15 Conductor, 24 AWG - 0.256"
Voltage Rating	300 V
Amperage	37 Conductor, 22 AWG - 2.0 A/Conductor
	25 Conductor, 22 AWG - 2.0 A/Conductor
	25 Conductor, 24 AWG - 2.0 A/Conductor
	15 Conductor, 24 AWG - 2.0 A/Conductor
Protection	NEMA 12
Operating Temperature	Max 80°C

CONNECTOR (CABLE)	CONDUCTOR
PIN 1	Black
PIN 2	White
PIN 3	Red
PIN 4	Green
PIN 5	Orange
PIN 6	Blue
PIN 7	White/Black
PIN 8	Red/Black
PIN 9	Green/Black
PIN 10	Orange/Black
PIN 11	Blue/Black
PIN 12	Black/White
PIN 13	Red/White
PIN 14	Green/White
PIN 15	Blue/White
PIN 16	Black/Red
PIN 17	White/Red
PIN 18	Orange/Red
PIN 19	Blue/Red
PIN 20	Red/Green
PIN 21	Orange/Green
PIN 22	Black/White/Red or Brown/White
PIN 23	White/Black/Red or Yellow/Black
PIN 24	Red/Black/White or Violet/White
PIN 25	Green/Black/White or Gray/Black
Pin 26	Orange/Black/White or Yellow
Pin 27	Blue/Black/White or Violet
Pin 28	Black/Red/Green or Gray
Pin 29	White/Red/Green or Pink
Pin 30	Red/Black/Green or Light Green
Pin 31	Green/Black/Orange or Orange/White
Pin 32	Orange/Black/Green or Pink/Black
Pin 33	Blue/White/Orange or Pink/Green
Pin 34	Black/White/Orange or Pink/Red
Pin 35	White/Red/Orange or Pink/Violet
Pin 36	Orange/White/Blue or Light Blue
Pin 37	White/Red/Blue or Light Brown
Not Used	Black/White/Green
Not Used	White/Black/Green
Not Used	Red/White/Green



## I/O Cables, Splitters and Accessories

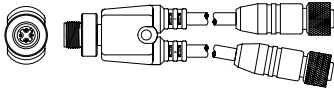

### MICRO DC SPLITTER 2 STRAIGHT MICRO FEMALE CONNECTORS

1 Meter - TA0401MC0JC05000

2 Meter - TA0402MC0JC05000

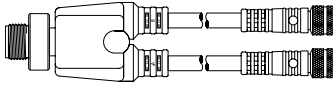

### MICRO DC SPLITTER 2 STRAIGHT PICO FEMALE CONNECTORS

1 Meter - TA0401MI0KC03000

2 Meter - TA0402MI0KC03000

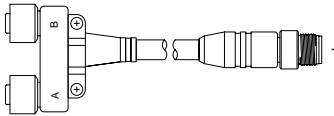

### MICRO DC "Y" WITH MALE CABLE

0.3 Meter - TA0401FJ0JC04000

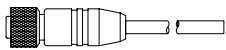

### MICRO FEMALE 4 POLE STRAIGHT 22 AWG EURO COLOR CODE

2 Meter - TC0402MCE0000000

5 Meter - TC0405MCE0000000

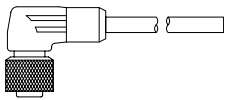

### MICRO FEMALE 4 POLE 90 DEGREE 22 AWG EURO COLOR CODE

2 Meter - TD0402MCE0000000

5 Meter - TD0405MCE0000000

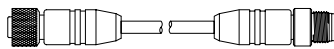

### MICRO F/M 4 POLE STRAIGHT 22 AWG EURO COLOR CODE

1 Meter - TC0401MC0TA04000

2 Meter - TC0402MC0TA04000

5 Meter - TC0405MC0TA04000

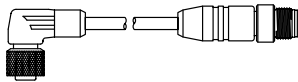

### MICRO F 90°/M STRAIGHT 22 AWG EURO COLOR CODE

1 Meter - TD0401MC0TA04000

2 Meter - TD0402MC0TA04000

5 Meter - TD0405MC0TA04000

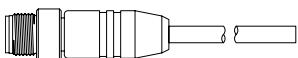

### MICRO MALE 4 POLE STRAIGHT 22 AWG EURO COLOR CODE

2 Meter - TA0402MCE0000000

5 Meter - TA0405MCE0000000

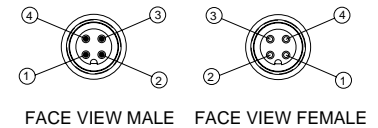
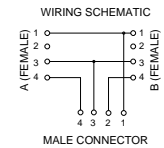
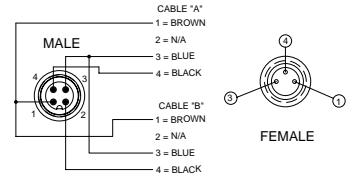
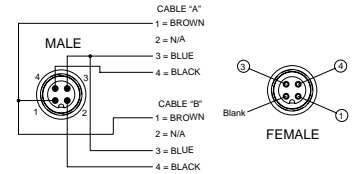

1 = Brown 3 = Blue  
2 = White 4 = Black





I/O Cables, Splitters and Accessories continued

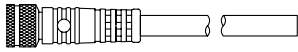

**PICO FEMALE 3 POLE STRAIGHT 26 AWG EURO COLOR CODE**

2 Meter - PC0302MEE0000000

5 Meter - PC0305MEE0000000

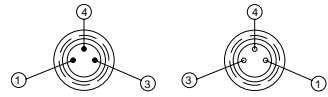

FACE VIEW MALE      FACE VIEW FEMALE  
 1 = Brown      3 = Blue  
 4 = Black

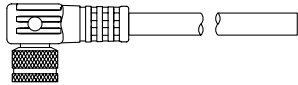

**PICO FEMALE 3 POLE 90° 26 AWG EURO COLOR CODE**

2 Meter - PD0302MEE0000000

5 Meter - PD0305MEE0000000

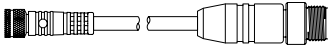

**MICRO MALE/PICO FEMALE 3 POLE 26 AWG EURO COLOR CODE**

2 Meter - TA0302ME0PC03000

5 Meter - TA0305ME0PC03000

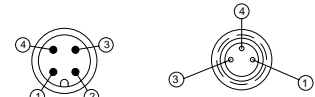

FACE VIEW MALE      FACE VIEW FEMALE  
 3 = Blue

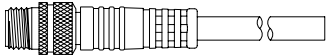

**PICO MALE 3 POLE STRAIGHT 26 AWG EURO COLOR CODE**

2 Meter - PA0302MEE0000000

5 Meter - PA0305MEE0000000



## Input Distribution Boxes

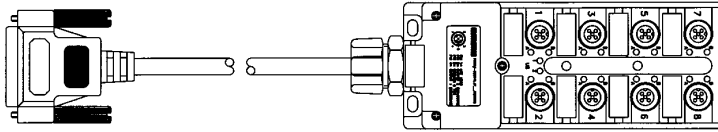

### 25 PIN SUB-D CONTR. SINGLE POINT - INPUTS

8 Port Distribution Box - 5 Pole 3 Wire/LED - NPN (Sinking)

2 Meters - DB81TLNR02M25S00

5 Meters - DB81TLNR05M25S00

10 Meters - DB81TLNR10M25S00

8 Port Distribution Box - 5 Pole 3 Wire/LED - PNP (Sourcing)

2 Meters - DB81TLPR02M25S00

5 Meters - DB81TLPR05M25S00

10 Meters - DB81TLPR10M25S00

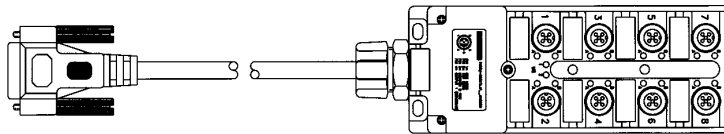

### 15 PIN SUB-D CONTR. SINGLE POINT - INPUTS

8 Port Distribution Box - 5 Pole 3 Wire/LED - NPN (Sinking)

2 Meters - DB81TLNR02M15S00

5 Meters - DB81TLNR05M15S00

10 Meters - DB81TLNR10M15S00

8 Port Distribution Box - 5 Pole 3 Wire/LED - PNP (Sourcing)

2 Meters - DB81TLPR02M15S00

5 Meters - DB81TLPR05M15S00

10 Meters - DB81TLPR10M15S00

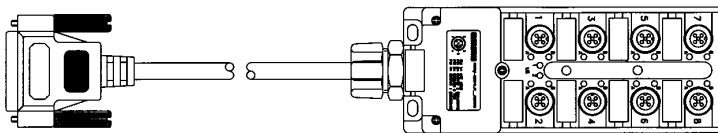

### 25 PIN SUB-D CONTR. DUAL POINT - INPUTS

8 Port Distribution Box - 5 Pole 4 Wire/LED - NPN (Sinking)

2 Meters - DB82TLNR02M25S00

5 Meters - DB82TLNR05M25S00

10 Meters - DB82TLNR10M25S00

8 Port Distribution Box - 5 Pole 4 Wire/LED - PNP (Sourcing)

2 Meters - DB82TLPR02M25S00

5 Meters - DB82TLPR05M25S00

10 Meters - DB82TLPR10M25S00



## Outputs Distribution Boxes and I/O D-Boxes without Cable

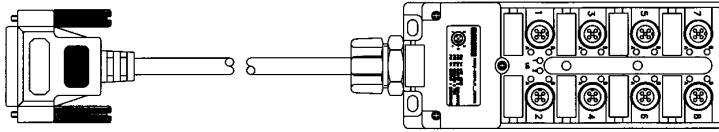

### 25 PIN SUB-D CONTR. SINGLE POINT - OUTPUTS

8 Port Distribution Box - 5 Pole 3 Wire/NO LED - PNP (Sourcing)

2 Meters - DB81TLJP02M25S00

5 Meters - DB81TLJP05M25S00

10 Meters - DB81TLJP10M25S00

### 25 PIN SUB-D CONTR. DUAL POINT - OUTPUTS

8 Port Distribution Box - 5 Pole 4 Wire/NO LED - PNP (Sourcing)

2 Meters - DB82TLJP02M25S00

5 Meters - DB82TLJP05M25S00

10 Meters - DB82TLJP10M25S00

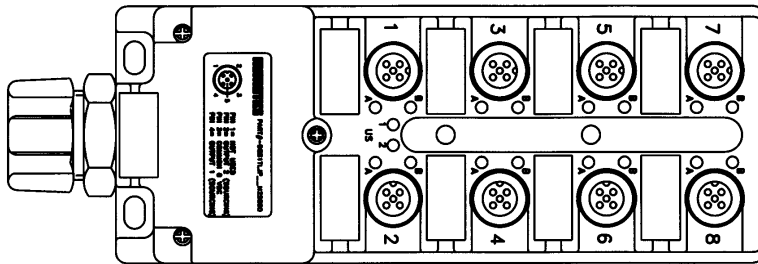

### D-BOXES WITHOUT CABLE - UNIVERSAL

8 Port Block - 5 Pole w/ LED's - NPN

DB82TLN000000000

8 Port Block - 5 Pole w/ LED's - PNP

DB82TLP000000000

8 Port Block - 5 Pole without LED's - Universal

DB82T0U000000000

## Dimensions

top dimensions = inches

bottom dimensions (in parenthesis) = millimeters

### TECHNICAL DATA

Molded Body/Housing	Pocan PBT
Threaded Sleeve	CuZn, Nickel Plated
Voltage Rating	10 - 30 VDC
Amperage	2 A per Signal
Protection	IP 68, NEMA 6P
Operating Temperature	-20°C to 90°C

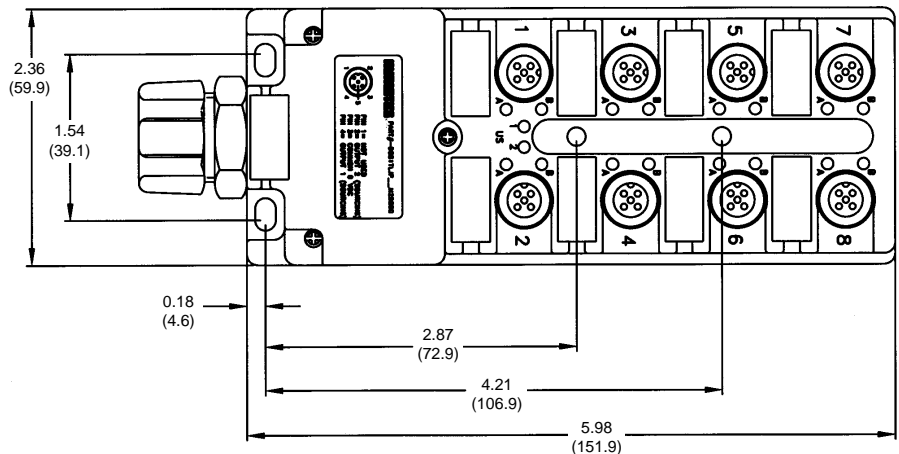

# numatics®



## World Class Supplier of Pneumatic Components



### World Headquarters

#### Numatics Incorporated

Phone: 248-887-4111

Fax: 248-887-9190

#### Numatics – Air Preparation

Phone: 810-667-3900

Fax: 810-667-3902

#### Numatics – Valves

Phone: 248-887-4111

Fax: 248-887-9190

#### Numatics – Miniature Valves

Phone: 248-960-1400

Fax: 248-960-2160

#### Numatics – Cylinders

Phone: 615-771-1200

Fax: 615-771-1201

#### Numatics – Rodless Cylinders

Phone: 519-452-1777

Fax: 519-452-3995

#### Numatics – Automation

Phone: 440-934-3200

Fax: 440-934-2288

### CANADA

#### Ontario

Numatics, Ltd.

Phone: 519-452-1777

Fax: 519-452-3995

#### Quebec

Numatics, Ltd.

Phone: 514-332-6444

Fax: 514-332-9273

#### British Columbia

Numatics, Ltd.

Phone: 604-574-0401

Fax: 604-574-3713

### EUROPE

#### Germany – European Headquarters

Numatics GmbH

Phone: 011-49-22 41-31 60-0

Fax: 011-49-22 41-31 60 40

#### Hungary

Numatics Kft.

Phone: 011-36-13 82 21 35

Fax: 011-36-12 04 39 47

### England

Numatics Limited

Phone: 011-44-1525-37 07 35

Fax: 011-44-1525-38 25 67

### France

Numatics s.a.r.l.

Phone: 011-33-1 41 21 48 88

Fax: 011-33-1 41 21 48 89

### Italy

Numatics srl

Phone: 011-39-030-373 19 99

Fax: 011-39-030-373 19 81

### Netherlands

Numatics B.V.

Phone: 011-31-418-65 29 50

Fax: 011-31-418-65 29 43

### Spain

Numatics Spain S.L.

Phone: 011-34-93-221 21 96

Fax: 011-34-93-221 35 14

### AFRICA

#### South Africa

Numatics SA (Pty) Ltd.

Phone: 011-27-11-8 65 44 52

Fax: 011-27-11-8 65 42 90

### LATIN & SOUTH AMERICA

#### Mexico

Numatics de Mexico S.A. de C.V.

Phone: 011-52-222-284 6176

Fax: 011-52-222-284 6179

#### Brazil

Valvair Comercial Ltda.

Phone: 011-55-12-351 2874

Fax: 011-55-12-351 1958

### ASIA & PACIFIC

#### Australia

Numatics Australia Pty. Ltd.

Phone: 011-61-3-95 63 86 00

Fax: 011-61-3-95 63 85 11

#### Taiwan – Asian Headquarters

Numatics Co, Ltd. Asia

Phone: 011-886-2-29 15 16 05

Fax: 011-886-2-29 14 18 97

For a comprehensive listing of all Numatics production and distribution facilities worldwide, visit [www.numatics.com](http://www.numatics.com)