

# Resistance thermometer For additional thermowell Model TR10-B

WIKA data sheet TE 60.02



for further Approvals,  
see page 16

## Applications

- Machine building, plant and vessel construction
- Energy and power plant technology
- Chemical industry
- Food and beverage industry
- Sanitary, heating and air-conditioning technology

## Special features

- Sensor ranges from  $-196 \dots +600 \text{ °C}$  [ $-320 \dots +1,112 \text{ °F}$ ]
- For mounting in all standard thermowell designs
- Spring-loaded measuring insert (replaceable)
- Pt100 or Pt1000 sensors
- Explosion-protected versions are available for many approval types

## Description

Resistance thermometers in this series can be combined with a large number of thermowell designs. Operation without thermowell is only recommended in certain applications.

A wide variety of possible combinations of Pt100 or Pt1000 sensor, connection head, insertion length, neck length, connection to thermowell etc. are available for the thermometers; suitable for any thermowell dimension and any application.

A large number of different explosion-protected approvals are available for the TR10-B.

Optionally we can fit analogue or digital transmitters from the WIKA range into the connection head of the TR10-B.



**Fig. left: Model TR10-B with BSZ connection head**

**Fig. right: Model TR10-B with 1/4000 connection head**

## Representation of the components

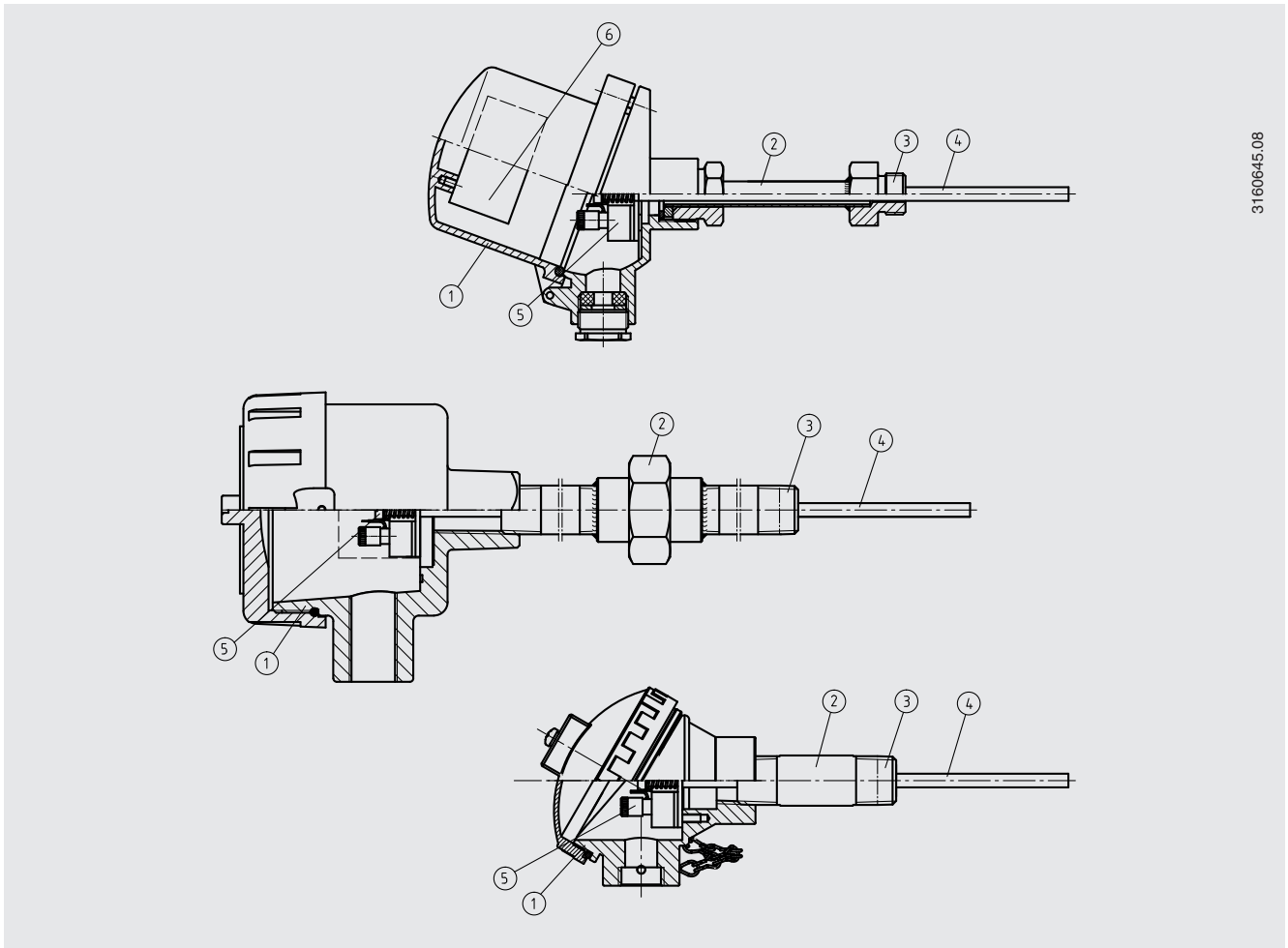

3160645.08

### Legend:

- ① Connection head
- ② Neck tube
- ③ Connection to thermowell
- ④ Measuring insert (TR10-A)
- ⑤ Terminal block/transmitter (option)
- ⑥ Transmitter (option)

## Overview of approvals for explosion protection

Approval	Explosion protection				
	Ex i (gas) Zone 0, 1, 2	Ex i (dust) Zone 20, 21, 22	Ex e (gas) Zone 1, 2	Ex t (dust) Zone 21, 22	Ex nA (gas) Zone 2
<b>ATEX</b>	x	x	x	x	x
<b>IECEX</b>	x	x	x	x	x
<b>EAC</b>	x	x	-	-	x
<b>Ex Ukraine</b>	x	x	-	-	-
<b>INMETRO</b>	x	x	-	-	-
<b>CCC</b>	x	x	x	-	-
<b>KCs</b>	x	-	-	-	-
<b>PESO</b>	x	-	-	-	-

→ For detailed information, see page „Approvals“ on page 16

# Measuring element

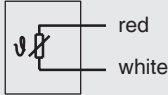
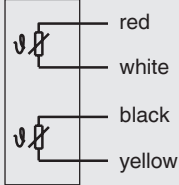
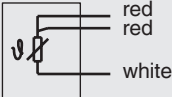
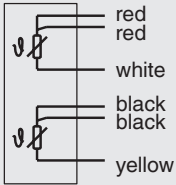
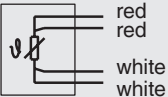
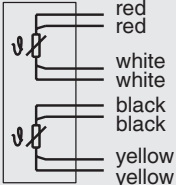
Measuring element			
Type of measuring element	Pt100, Pt1000 <sup>1)</sup>		
Measuring current	0.1 ... 1.0 mA		
Connection method			
Single elements	Dual elements		
1 x 2-wire		2 x 2-wire	
1 x 3-wire		2 x 3-wire	
1 x 4-wire		2 x 4-wire <sup>2)</sup>	
<b>Validity limits of the class accuracy in accordance with IEC 60751</b>			
Class B $\pm (0.30 + 0.0050   t  ) ^4)$	Wire-wound	<ul style="list-style-type: none"> <li>■ -196 ... +600 °C [-321 ... +1112 °F]</li> <li>■ -196 ... +450 °C [-321 ... +842 °F]</li> </ul>	
	Thin film	<ul style="list-style-type: none"> <li>■ -50 ... +500 °C [-58 ... +932 °F]</li> <li>■ -50 ... +250 °C [-58 ... +482 °F]</li> </ul>	
Class A <sup>3)</sup> $\pm (0.15 + 0.0020   t  ) ^4)$	Wire-wound	-100 ... +450 °C [-148 ... +842 °F]	
	Thin film	-30 ... +300 °C [-22 ... +572 °F]	
Class AA <sup>3)</sup> $\pm (0.10 + 0.0017   t  ) ^4)$	Wire-wound	-50 ... +250 °C [-58 ... +482 °F]	
	Thin film	0 ... 150 °C [32 ... 302 °F]	

1) Pt1000 only available as a thin-film measuring resistor

2) Not for 3 mm [0.118 in] diameter

3) Not for 2-wire connection method

4) | t | is the numerical value of the temperature in °C without consideration of the sign

→ For detailed specifications for Pt100 sensors, see technical information IN 00.17 at [www.wika.com](http://www.wika.com).

The table shows the temperature ranges listed in the respective standards, in which the tolerance values (class accuracies) are valid.



- The combinations of a 2-wire connection with class A or class AA are not permissible, since the lead resistance of the MI cable and the connection lead negates the higher sensor accuracy.

Maximum probe length including connection cable:

- Class B, 3-wire connection: ~ 30 m [98 ft]
- Class A, 3-wire connection: ~ 10 m [33 ft]
- Class AA, 3-wire connection: ~ 3 m [10 ft]
- Longer probe/cable lengths should be designed with a 4-wire connection, since this connection method has no length effect on the accuracy.

## Connection head

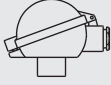
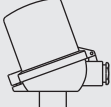
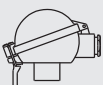
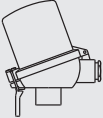
### ■ European designs per EN 50446 / DIN 43735

Model	Material	Cable inlet thread size	Ingress protection (max.) <sup>1)</sup> IEC/EN 60529	Cap	Surface	Connection to neck tube	
 <b>BS</b>	Aluminium	■ M20 x 1.5 ■ ½ NPT	IP65 <sup>3)</sup>	Flat cover with 2 screws	Blue, painted (RAL 5022)	■ M24 x 1.5 ■ ½ NPT	
 <b>BSZ</b>	Aluminium	■ M20 x 1.5 ■ ½ NPT	IP65 <sup>3)</sup>	Spherical hinged cover with cylinder head screw	Blue, painted (RAL 5022)	■ M24 x 1.5 ■ ½ NPT	
	<b>BSZ-K</b>	Plastic	■ M20 x 1.5 ■ ½ NPT	IP65	Spherical hinged cover with cylinder head screw	Black	M24 x 1.5
 <b>BSZ-H</b>	Aluminium	■ M20 x 1.5 ■ ½ NPT	IP65 <sup>3)</sup>	Raised hinged cover with cylinder head screw	Blue, painted (RAL 5022)	■ M24 x 1.5 ■ ½ NPT	
	<b>BSZ-H (2 x cable outlet)</b>	Aluminium	■ 2 x M20 x 1.5 ■ 2 x ½ NPT	IP65 <sup>3)</sup>	Raised hinged cover with cylinder head screw	Blue, painted (RAL 5022)	M24 x 1.5
	<b>BSZ-H / DIH10<sup>2)</sup></b>	Aluminium	■ M20 x 1.5 ■ ½ NPT	IP65	Raised hinged cover with cylinder head screw	Blue, painted (RAL 5022)	■ M24 x 1.5 ■ ½ NPT
	<b>BSZ-HK</b>	Plastic	■ M20 x 1.5 ■ ½ NPT	IP65	Raised hinged cover with cylinder head screw	Black	M24 x 1.5
 <b>BSS</b>	Aluminium	■ M20 x 1.5 ■ ½ NPT	IP65	Spherical hinged cover with clamping lever	Blue, painted (RAL 5022)	■ M24 x 1.5 ■ ½ NPT	
 <b>BSS-H</b>	Aluminium	■ M20 x 1.5 ■ ½ NPT	IP65	Raised hinged cover with clamping lever	Blue, painted (RAL 5022)	■ M24 x 1.5 ■ ½ NPT	
 <b>BVS</b>	Stainless steel	M20 x 1.5	IP65	Precision-cast screw-on lid	Natural finish, electropolished	M24 x 1.5	

Further thread sizes on request

Model	Explosion protection					
	Without	Ex i (gas) Zone 0, 1, 2	Ex i (dust) Zone 20, 21, 22	Ex e (gas) Zone 1, 2	Ex t (dust) Zone 21, 22	Ex nA (gas) Zone 2
<b>BS</b>	x	x	x	-	-	-
<b>BSZ</b>	x	x	x	x <sup>4)</sup>	x <sup>4)</sup>	x <sup>5)</sup>
<b>BSZ-H</b>	x	x	x	x <sup>4)</sup>	x <sup>4)</sup>	x <sup>5)</sup>
<b>BSZ-H (2 x cable outlet)</b>	x	x	x	x <sup>4)</sup>	x <sup>4)</sup>	x <sup>5)</sup>
<b>BSZ-H / DIH10<sup>2)</sup></b>	x	x	-	-	-	-
<b>BSS</b>	x	x	-	-	-	-
<b>BSS-H</b>	x	x	-	-	-	-
<b>BVS</b>	x	x	-	-	-	-
<b>BSZ-K</b>	x	x	-	-	-	-
<b>BSZ-HK</b>	x	x	-	-	-	-

1) IP ingress protection of the connection head. The IP ingress protection of the complete TR10-B instrument does not necessarily have to correspond to the connection head.





2) LED display DIH10

3) Ingress protections, describing temporary or permanent immersion, on request

4) Only ATEX

5) Only ATEX and EAC

■ International connection heads

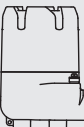
Model	Material	Cable inlet thread size	Ingress protection (max.) <sup>1)</sup> IEC/EN 60529	Cap	Surface	Connection to neck tube	
	<b>KN4-A</b>	Aluminium	■ ½ NPT ■ M20 x 1.5	IP65 <sup>3)</sup>	Screw-on lid	Blue, painted (RAL 5022)	■ M24 x 1.5 ■ ½ NPT
	<b>KN4-P<sup>2)</sup></b>	Polypropylene	½ NPT	IP65 <sup>3)</sup>	Screw-on lid	White	½ NPT
	<b>1/4000 F</b>	Aluminium	■ ½ NPT ■ ¾ NPT ■ M20 x 1.5	IP66 <sup>3)</sup>	Screw-on lid	Blue, painted (RAL 5022)	½ NPT
	<b>1/4000 S</b>	Stainless steel	■ ½ NPT ■ ¾ NPT ■ M20 x 1.5	IP66 <sup>3)</sup>	Screw-on lid	Natural finish	½ NPT
	<b>7/8000 W</b>	Aluminium	■ ½ NPT ■ ¾ NPT ■ M20 x 1.5	IP66 <sup>3)</sup>	Screw-on lid	Blue, painted (RAL 5022)	½ NPT
	<b>7/8000 S</b>	Stainless steel	■ ½ NPT ■ ¾ NPT ■ M20 x 1.5	IP66 <sup>3)</sup>	Screw-on lid	Natural finish	½ NPT
	<b>7/8000 W / DIH50<sup>4)</sup></b>	Aluminium	■ ½ NPT ■ ¾ NPT ■ M20 x 1.5	IP66 <sup>3)</sup>	Screw-on lid	Blue, painted (RAL 5022)	½ NPT
	<b>7/8000 S / DIH50<sup>4)</sup></b>	Stainless steel	■ ½ NPT ■ ¾ NPT ■ M20 x 1.5	IP66 <sup>3)</sup>	Screw-on lid	Natural finish	½ NPT
	<b>PIH-L<sup>5)</sup></b>	Aluminium	■ ½ NPT / closed ■ M20 x 1.5 / closed ■ 2 x ½ NPT ■ 2 x M20 x 1.5	IP66 <sup>3)</sup>	Screw-on lid, flat	Blue upper body, painted (RAL 5022) Grey lower body, painted (RAL 7032)	■ ½ NPT ■ M20 x 1.5
	<b>PIH-H<sup>5)</sup></b>	Aluminium	■ ½ NPT ■ M20 x 1.5 ■ 2 x ½ NPT ■ 2 x M20 x 1.5	IP66 <sup>3)</sup>	Screw-on lid, high	Blue upper body, painted (RAL 5022) Grey lower body, painted (RAL 7032)	■ ½ NPT ■ M20 x 1.5

Model	Explosion protection					
	Without	Ex i (gas) Zone 0, 1, 2	Ex i (dust) Zone 20, 21, 22	Ex e (gas) Zone 1, 2	Ex t (dust) Zone 21, 22	Ex nA (gas) Zone 2
<b>KN4-A</b>	x	x	-	-	-	-
<b>KN4-P<sup>2)</sup></b>	x	-	-	-	-	-
<b>1/4000 F</b>	x	x	x	x	x	x
<b>1/4000 S</b>	x	x	x	x	x	x
<b>7/8000 W</b>	x	x	x	x	x	x
<b>7/8000 S</b>	x	x	x	x	x	x
<b>7/8000 W / DIH50<sup>4)</sup></b>	x	x	x	-	-	-
<b>7/8000 S / DIH50<sup>4)</sup></b>	x	x	x	-	-	-
<b>PIH-L / PIH-H<sup>5)</sup></b>	x	x	x	x	x	x

1) IP ingress protection of the connection head. The IP ingress protection of the complete TR10-B instrument does not necessarily have to correspond to the connection head.

2) On request

3) Suitable sealing/cable gland required

4) LC display DIH50

5) Available from Q2/2023

## Connection head with digital indicator













**Connection head BSZ-H with LED display model DIH10**  
→ see data sheet AC 80.11



**Connection head 7/8000 W with LC display model DIH50**  
→ see data sheet AC 80.10

To operate the digital displays, a transmitter with a 4 ... 20 mA output is always required.

## Cable inlet

Cable inlet	Colour	Ingress protection (max.) IEC/EN 60529 <sup>1)</sup>	Cable inlet thread size	Min./max. ambient temperature
 <b>Standard cable inlet <sup>2)</sup></b>	Natural finish	IP65	<ul style="list-style-type: none"> <li>■ M20 x 1.5</li> <li>■ ½ NPT</li> </ul>	-40 ... +80 °C [-40 ... +176 °F]
 <b>Plastic cable gland (cable Ø 6 ... 10 mm) <sup>2)</sup></b>	<ul style="list-style-type: none"> <li>■ Black</li> <li>■ Grey</li> </ul>	IP66 <sup>3)</sup>	<ul style="list-style-type: none"> <li>■ M20 x 1.5</li> <li>■ ½ NPT</li> </ul>	-40 ... +80 °C [-40 ... +176 °F]
 <b>Plastic cable gland (cable Ø 6 ... 10 mm), Ex e <sup>2)</sup></b>	<ul style="list-style-type: none"> <li>■ Light blue</li> <li>■ Black</li> </ul>	IP66 <sup>3)</sup>	<ul style="list-style-type: none"> <li>■ M20 x 1.5</li> <li>■ ½ NPT</li> </ul>	<ul style="list-style-type: none"> <li>■ -20 ... +80 °C [-4 ... +176 °F]</li> <li>■ -40 ... +70 °C [-40 ... +158 °F]</li> </ul>
 <b>Nickel-plated brass cable gland (cable Ø 6 ... 12 mm)</b>	Natural finish	IP66 <sup>3)</sup>	<ul style="list-style-type: none"> <li>■ M20 x 1.5</li> <li>■ ½ NPT</li> </ul>	-60 <sup>4)</sup> / -40 ... +80 °C [-76 / -40 ... +176 °F]
 <b>Nickel-plated brass cable gland (cable Ø 6 ... 12 mm), Ex e</b>	Natural finish	IP66 <sup>3)</sup>	<ul style="list-style-type: none"> <li>■ M20 x 1.5</li> <li>■ ½ NPT</li> </ul>	-60 <sup>4)</sup> / -40 ... +80 °C [-76 / -40 ... +176 °F]
 <b>Stainless steel cable gland (cable Ø 7 ... 12 mm)</b>	Natural finish	IP66 <sup>3)</sup>	<ul style="list-style-type: none"> <li>■ M20 x 1.5</li> <li>■ ½ NPT</li> </ul>	-60 <sup>4)</sup> / -40 ... +80 °C [-76 / -40 ... +176 °F]
 <b>Stainless steel cable gland (cable Ø 7 ... 12 mm), Ex e</b>	Natural finish	IP66 <sup>3)</sup>	<ul style="list-style-type: none"> <li>■ M20 x 1.5</li> <li>■ ½ NPT</li> </ul>	-60 <sup>4)</sup> / -40 ... +80 °C [-76 / -40 ... +176 °F]
 <b>Plain threaded</b>	-	IP00	<ul style="list-style-type: none"> <li>■ M20 x 1.5</li> <li>■ ½ NPT</li> </ul>	-
 <b>2 x plain threaded <sup>5)</sup></b>	-	IP00	<ul style="list-style-type: none"> <li>■ 2 x M20 x 1.5</li> <li>■ 2 x ½ NPT</li> </ul>	-
 <b>Junction box M12 x 1 (4-pin) <sup>6)</sup></b>	-	IP65	M20 x 1.5	-40 ... +80 °C [-40 ... +176 °F]
 <b>Sealing plugs for shipping</b>	Transparent	-	<ul style="list-style-type: none"> <li>■ M20 x 1.5</li> <li>■ ½ NPT</li> </ul>	-40 ... +80 °C [-40 ... +176 °F]

- 1) IP ingress protection of the cable gland. The IP protection of the complete TR10-B instrument does not necessarily have to correspond to the cable gland.
- 2) Not available for BVS connection head
- 3) Ingress protections, describing temporary or permanent immersion, on request
- 4) Special version on request (explosion-protected versions only available with specific approvals)
- 5) Only for BSZ-H connection head
- 6) Not available for ½ NPT thread size cable entry

Cable inlet	Explosion protection					
	With-out	Ex i (gas) Zone 0, 1, 2	Ex i (dust) Zone 20, 21, 22	Ex e (gas) Zone 1, 2	Ex t (dust) Zone 21, 22	Ex nA (gas) Zone 2
Standard cable inlet <sup>1)</sup>	x	x	-	-	-	-
Plastic cable gland <sup>1)</sup>	x	x	-	-	-	-
Plastic cable gland (light blue), Ex e <sup>1)</sup>	x	x	x	-	-	-
Plastic cable gland (black), Ex e <sup>1)</sup>	x	x	x	x	x	x
Brass cable gland, nickel-plated	x	x	x	-	-	-
Brass cable gland, nickel-plated, Ex e	x	x	x	x	x	x
Stainless steel cable gland	x	x	x	-	-	-
Stainless steel cable gland, Ex e	x	x	x	x	x	x
Plain threaded	x	x	x <sup>5)</sup>	x <sup>5)</sup>	x <sup>5)</sup>	x <sup>5)</sup>
2 x plain threaded <sup>2)</sup>	x	x	x <sup>5)</sup>	x <sup>5)</sup>	x <sup>5)</sup>	x <sup>5)</sup>
Junction box M12 x 1 (4-pin) <sup>3)</sup>	x	x <sup>4)</sup>	x <sup>4)</sup>	-	-	-
Sealing plugs for shipping	Not applicable, transport protection <sup>5)</sup>					

- 1) Not available for BVS connection head  
2) Only for BSZ-H connection head  
3) Not available for ½ NPT thread size cable entry  
4) With appropriate mating connector connected  
5) Suitable cable gland required for operation

## Measuring insert

Measuring insert		
<b>Versions</b>	Vibration-resistant sheathed measuring cable (MI cable)	
Standard	Standard soldering lugs	
Option	Recessed soldering lugs	
<b>Optimal heat transfer</b>	Requirement <ul style="list-style-type: none"> <li>■ Correct measuring insert length</li> <li>■ Correct measuring insert diameter</li> </ul>	
	Bore diameter of the thermowell	Max. 1 mm [0.039 in] larger than the measuring insert diameter
	Gap width	With gap widths > 0.5 mm [> 0.020 in] between thermowell and measuring insert: → Negative impact on heat transfer → Unfavourable response behaviour of the thermometer
<b>Insertion length</b>	When fitting the measuring insert into a thermowell, it is very important to determine the correct insertion length (= thermowell length for tip thicknesses of ≤ 5.5 mm [≤ 0.217 in]). In order to ensure that the measuring insert is firmly pressed down onto the bottom of the thermowell, the insert must be spring-loaded (spring travel: max. 10 mm [0.394 in]).	
<b>Spring travel</b>	Max. 10 mm [0.394 in]	

# Dimensions in mm [in]

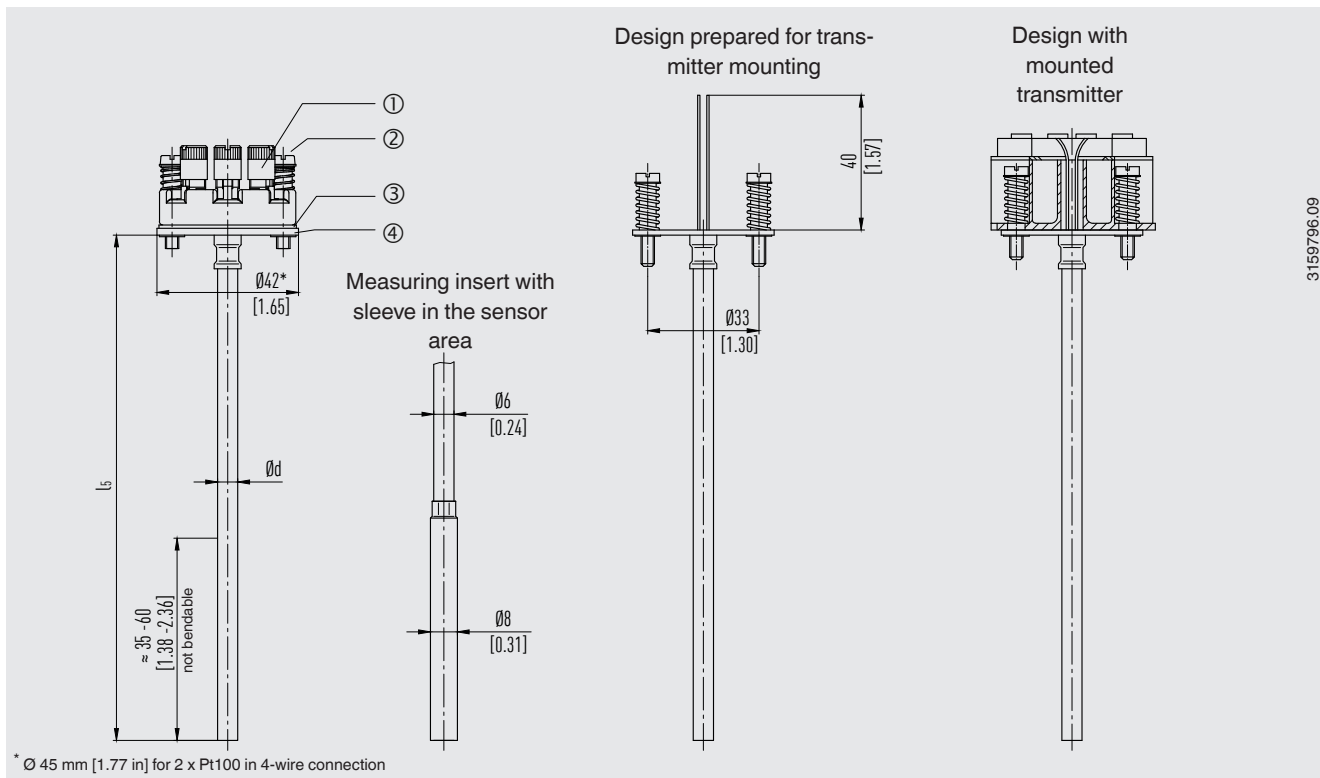

### Legend

- ① Connection terminal
- ② Spring-loaded screw
- ③ Insulation washer
- ④ Terminal plate

Measuring insert diameter Ø d in mm		Index per DIN 43735	Tolerance in mm	Sheath material
3 [0.118 in]	Standard	30	3 ±0.05	■ 1.4571 ■ 316L
6 [0.236 in]	Standard	60	6 <sup>0</sup> / <sub>-0.1</sub>	■ 1.4571
8 [0.315 in] (6 mm [0.236 in] with sleeve)	Standard	-	8 <sup>0</sup> / <sub>-0.1</sub>	■ 1.4571
8 [0.315 in]	Standard	80	8 <sup>0</sup> / <sub>-0.1</sub>	■ 1.4571 ■ 316L



### Legend:

- l<sub>5</sub> Measuring insert length
- Ø d Measuring insert diameter

3159796.09



# Transmitter

Transmitter models	Model T15	Model T32
Transmitter data sheet	TE 15.01	TE 32.04
Figure		
<b>Output</b>		
4 ... 20 mA	x	x
HART® protocol	-	x
<b>Connection method</b>		
	<ul style="list-style-type: none"> <li>■ 1 x 2-wire</li> <li>■ 1 x 3-wire</li> <li>■ 1 x 4-wire</li> </ul>	<ul style="list-style-type: none"> <li>■ 1 x 2-wire</li> <li>■ 1 x 3-wire</li> <li>■ 1 x 4-wire</li> <li>■ 2 x 2-wire</li> </ul>
Measuring current	< 0.2 mA	< 0.3 mA
Explosion protection	Option	Option
<b>Mounting types</b>		
Mounting onto the measuring insert	With mounting on the measuring insert, the transmitter replaces the terminal block and is fixed directly to the terminal plate of the measuring insert.	
Mounted within the cover of the connection head	Mounting the transmitter in the cover of the connection head is preferable to mounting it on the measuring insert. With this mounting type, for one, a better thermal insulation is ensured, and in addition, exchange and mounting for servicing is simplified.	

## Mounting types

Mounting onto the measuring insert

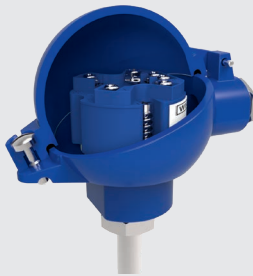

Measuring insert with mounted transmitter (here: Model T32)

Measuring insert prepared for transmitter mounting

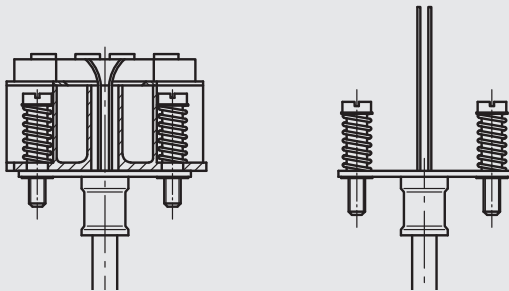

Mounted within the cover of the connection head

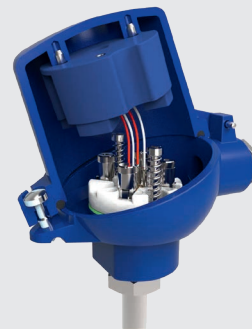

When using dual sensors in conjunction with a single transmitter, sensor 1 is connected to the transmitter. The connection leads of sensor 2 (insulated against short-circuits) protrude loosely into the connection head.

The exception is the combination of a 2 x 2-wire in conjunction with a T32 transmitter in the “redundancy” configuration. In this case, both sensors are connected to the T32.

Possible mounting positions for transmitters	Model T15	Model T32
BS	○	-
BSZ	○	○
BSZ-H	●	●
BSZ-H (2x cable outlet)	●	●
BSZ-H / DIH10	○	○
BSS	○	○
BSS-H	●	●
BVS	○	○
BSZ-K	○	○
BSZ-HK	●	●
KN4-A	○	○
KN4-P	○	○
1/4000	○	○
7/8000	○	○
7/8000 / DIH50	○	○
PIH-L / PIH-H	○	○

Legend:

- Mounted instead of terminal block
- Mounted within the cover of the connection head
- Mounting not possible

The mounting of a transmitter on the measuring insert is possible with all the connection heads listed here. The fitting of a transmitter in the (screw) cap of a connection head is not possible. Mounting of 2 transmitters on request.

For a correct determination of the overall measuring deviation, the sensor and transmitter measuring deviations must be added.

### Functional safety with model T32 temperature transmitter (option)



In safety-critical applications, the entire measuring chain must be taken into consideration in terms of the safety parameters. The SIL classification allows the assessment of the risk reduction achieved by the safety installations.

Selected TR10-B resistance thermometers, in combination with a suitable temperature transmitter (e.g. model T32.1S, TÜV certified SIL version for protection systems developed in accordance with IEC 61508), are suitable as sensors for safety functions to SIL 2.

For SIL 3 applications, WIKA recommends the use of two individual TR10-B with one SIL-certified T32 transmitter connected to each.

→ For detailed specifications, see technical information IN 00.19 at [www.wika.com](http://www.wika.com).

# Neck tube

## Versions

Neck tube design	Diameter	Connection to head	Connection to thermowell	Material
Neck tube per DIN 43772	<ul style="list-style-type: none"> <li>■ 12 x 1.5 mm [0.472 x 0.059 in]</li> <li>■ 12 x 2.5 mm [0.472 x 0.098 in]</li> </ul>	M24 x 1.5 (swivel connection)	<ul style="list-style-type: none"> <li>■ Mounting thread</li> <li>■ Compression fitting</li> <li>■ Union nut</li> <li>■ Male nut</li> <li>■ Without threaded connection, plain</li> </ul>	1.4571
	14 x 2.5 mm [0.551 x 0.098 in]	M24 x 1.5 (swivel connection)	<ul style="list-style-type: none"> <li>■ Mounting thread</li> <li>■ Union nut</li> <li>■ Male nut</li> </ul>	1.4571
Neck tube with counter nut to head	14 x 2.5 mm [0.551 x 0.098 in]	M20 x 1.5 (with counter nut)	Mounting thread	1.4571
Double threaded hex bushing (with hexagonal spanner flats)	-	M24 x 1.5, ½ NPT	Mounting thread	1.4571
“Nipple-union-nipple” neck tube (nipple-union-nipple)	~ 22 mm [~ 0.9 in]	½ NPT	Mounting thread	316
	~ 27 mm [~ 1.1 in]	¾ NPT	Mounting thread	316
Double threaded hex bushing (tube section)	~ 22 mm [~ 0.9 in]	½ NPT	Mounting thread	316
	~ 27 mm [~ 1.1 in]	¾ NPT	Mounting thread	316

## Thread sizes

Neck tube design	Diameter	Thread to the thermowell
Neck tube per DIN 43772	<ul style="list-style-type: none"> <li>■ 12 x 1.5 mm [0.472 x 0.059 in]</li> <li>■ 12 x 2.5 mm [0.472 x 0.098 in]</li> </ul>	<ul style="list-style-type: none"> <li>■ G ½ B</li> <li>■ G ¾ B</li> <li>■ G ¼ B</li> <li>■ M20 x 1.5</li> <li>■ M18 x 1.5</li> <li>■ M14 x 1.5</li> <li>■ ½ NPT</li> <li>■ ¾ NPT</li> <li>■ G ½ B compression fitting (metal ferrule)</li> <li>■ G ¾ B compression fitting (metal ferrule)</li> <li>■ M18 x 1.5 compression fitting (metal ferrule)</li> <li>■ M20 x 1.5 compression fitting (metal ferrule)</li> <li>■ G ½ B union nut</li> <li>■ G ¾ B union nut</li> <li>■ M20 x 1.5 union nut</li> <li>■ G ½ B male nut</li> <li>■ G ¾ B male nut</li> <li>■ M20 x 1.5 male nut</li> <li>■ Without threaded connection, plain</li> </ul>
Neck tube per DIN 43772	14 x 2.5 mm [0.551 x 0.098 in]	<ul style="list-style-type: none"> <li>■ G ½ B</li> <li>■ G ¾ B</li> <li>■ G ¼ B</li> <li>■ M20 x 1.5</li> <li>■ M18 x 1.5</li> <li>■ M14 x 1.5</li> <li>■ ½ NPT</li> <li>■ ¾ NPT</li> <li>■ G ½ B union nut</li> <li>■ G ¾ B union nut</li> <li>■ M20 x 1.5 union nut</li> <li>■ G ½ B male nut</li> <li>■ G ¾ B male nut</li> <li>■ M20 x 1.5 male nut</li> </ul>

Neck tube design	Diameter	Thread to the thermowell
Neck tube with counter nut to head	14 x 2.5 mm [0.551 x 0.098 in]	<ul style="list-style-type: none"> <li>■ ½ NPT</li> <li>■ ¾ NPT</li> <li>■ G ½ B</li> <li>■ G ¾ B</li> <li>■ G ¼ B</li> <li>■ M14 x 1.5</li> <li>■ M18 x 1.5</li> <li>■ M20 x 1.5</li> </ul>
Double threaded hex bushing (with hexagonal spanner flats)	-	<ul style="list-style-type: none"> <li>■ G ½ B</li> <li>■ G ¾ B</li> <li>■ G ¼ B</li> <li>■ ½ NPT</li> <li>■ ¾ NPT</li> <li>■ M14 x 1.5</li> <li>■ M18 x 1.5</li> <li>■ M20 x 1.5</li> </ul>
“Nipple-union-nipple” neck tube	~ 22 mm [~ 0.9 in]	½ NPT
	~ 27 mm [~ 1.1 in]	¾ NPT
Double threaded hex bushing (tube section)	~ 22 mm [~ 0.9 in]	½ NPT
	~ 27 mm [~ 1.1 in]	¾ NPT

### Neck lengths

Neck tube design	Neck length	Min. / Max. neck length
Neck tube per DIN 43772	150 mm [~ 6 in]	<ul style="list-style-type: none"> <li>■ 30 mm [~ 1.2 in]</li> <li>■ 500 mm [~ 20 in]</li> </ul>
Neck tube per DIN 43772, plain	150 mm [~ 6 in]	<ul style="list-style-type: none"> <li>■ 75 mm [~ 3 in]</li> <li>■ 900 mm [~ 35 in]</li> </ul>
Neck tube with counter nut to head	150 mm [~ 6 in]	<ul style="list-style-type: none"> <li>■ 75 mm [~ 3 in]</li> <li>■ 250 mm [~ 10 in]</li> </ul>
<b>Double threaded hex bushing (with hexagonal spanner flats)</b>		
M24 x 1.5 to connection head, parallel thread to thermowell	13 mm [0.512 in]	-
1/2 NPT to connection head, parallel thread to thermowell	~ 25 mm [1 in]	-
M24 x 1.5 to connection head, tapered thread to thermowell	~ 25 mm [1 in]	-
1/2 NPT to connection head, tapered thread to thermowell	~ 25 mm [1 in]	-
“Nipple-union-nipple” neck tube	~ 150 mm [6 in]	<ul style="list-style-type: none"> <li>■ ~ 75 mm [3 in]</li> <li>■ ~ 250 mm [10 in]</li> </ul>
Double threaded hex bushing (tube section)	~ 50 mm [2 in]	<ul style="list-style-type: none"> <li>■ ~ 50 mm [2 in]</li> <li>■ ~ 250 mm [10 in]</li> </ul>

The neck tube is screwed into the connection head. The neck length depends on the intended use. Usually an isolation is bridged by the neck tube. Also, in many cases, the neck tube serves as a cooling element between the connection head and the medium, in order to protect a possible built-in transmitter from high medium temperatures.

Other versions on request.

## Operating conditions

Operating conditions	
<b>Ambient and storage temperature</b>	<ul style="list-style-type: none"> <li>■ -40 ... +80 °C [-40 ... +176 °F]</li> <li>■ -60<sup>1)</sup> ... +80 °C [-76 ... +176 °F]</li> </ul>
<b>Vibration resistance</b>	<p>The information on vibration resistance refers to the tip of the measuring insert.            → For detailed specifications on the vibration resistance of Pt100 sensors, see technical information IN 00.17 at <a href="http://www.wika.com">www.wika.com</a>.</p>

1) Special version on request (explosion-protected versions only available with specific approvals)

Examples of vibration resistance		
	Measuring insert Ø 6 mm [0.236 in]	Measuring insert Ø 3 mm [0.118 in]
<b>Sensor</b>	<ul style="list-style-type: none"> <li>■ 1 x Pt100 (thin film)</li> <li>■ 2 x Pt100 (thin film)</li> </ul>	<ul style="list-style-type: none"> <li>■ 1 x Pt100 (thin film)</li> <li>■ 2 x Pt100 (thin film)</li> </ul>
Connection method	<ul style="list-style-type: none"> <li>■ 3-wire</li> <li>■ 4-wire</li> </ul>	<ul style="list-style-type: none"> <li>■ 3-wire</li> <li>■ 4-wire (only 1 x Pt100)</li> </ul>
Diameter	Ø 6 mm [0.236 in]	Ø 3 mm [0.118 in]
Insertion length (A) + neck length (N)	100 ... 1,100 mm [~ 4 ... 43 in]	100 ... 1,100 mm [~ 4 ... 43 in]
Material	<ul style="list-style-type: none"> <li>■ Stainless steel 1.4571</li> <li>■ Stainless steel 316L</li> </ul>	<ul style="list-style-type: none"> <li>■ Stainless steel 1.4571</li> <li>■ Stainless steel 316L</li> </ul>
Vibration resistance		
Standard probe tip, (max. 3 g amplitude / 6 g peak-to-peak)	x	x
Vibration-resistant probe tip (max. 10 g amplitude / 20 g peak-to-peak)	x	x
Highly vibration-resistant probe tip (max. 25 g amplitude / 50 g peak-to-peak)	On request	On request
Extremely vibration-resistant probe tip (max. 50 g amplitude / 100 g peak-to-peak)	On request	-

Vibration resistance of thermometers in other configurations as well as vibration resistance higher than 50 g amplitude / 100 g tip - tip on request.

The thermometer designs listed above describe instruments in standard designs.

## IP ingress protection per IEC/EN 60529

First index number	Degree of protection / Short description	Test parameters
<b>Degrees of protection against solid foreign bodies (defined by the 1st index number)</b>		
5	Dust-protected	Per IEC/EN 60529
6	Dust-tight	Per IEC/EN 60529
<b>Degrees of protection against water (defined by the 2nd index number)</b>		
4	Protected against splash water	Per IEC/EN 60529
5	Protected against water jets	Per IEC/EN 60529
6	Protected against strong water jets	Per IEC/EN 60529
7 <sup>1)</sup>	Protected against the effects of temporary immersion in water	Per IEC/EN 60529
8 <sup>1)</sup>	Protected against the effects of permanent immersion in water	As agreed upon

1) Ingress protections, describing temporary or permanent immersion, on request

Standard ingress protection of model TR10-B is IP65.

The specified degrees of protection apply under the following conditions:

- Use of a suitable thermowell (without suitable thermowell: IP40)
- Use of a suitable cable gland
- Use of a cable cross-section appropriate for the gland or select the appropriate cable gland for the available cable
- Adhere to the tightening torques for all threaded connections

<b>Examples of response time</b>		
	<b>Measuring insert Ø 6 mm [0.236 in]</b>	<b>Measuring insert Ø 3 mm [0.118 in]</b>
<b>Sensor</b>	<ul style="list-style-type: none"> <li>■ 1 x Pt100 (thin film)</li> <li>■ 2 x Pt100 (thin film)</li> </ul>	<ul style="list-style-type: none"> <li>■ 1 x Pt100 (thin film)</li> <li>■ 2 x Pt100 (thin film)</li> </ul>
Connection method	<ul style="list-style-type: none"> <li>■ 3-wire</li> <li>■ 4-wire</li> </ul>	<ul style="list-style-type: none"> <li>■ 3-wire</li> <li>■ 4-wire (only 1 x Pt100)</li> </ul>
Diameter	Ø 6 mm [0.236 in]	Ø 3 mm [0.118 in]
Insertion length (A) + neck length (N)	100 ... 1,100 mm [~ 4 ... 43 in]	100 ... 1,100 mm [~ 4 ... 43 in]
Material	<ul style="list-style-type: none"> <li>■ Stainless steel 1.4571</li> <li>■ Stainless steel 316L</li> </ul>	<ul style="list-style-type: none"> <li>■ Stainless steel 1.4571</li> <li>■ Stainless steel 316L</li> </ul>
<b>Response time in seconds (+/- 10 %)</b>		
$t_{0,5}$	3.8	2.8
$t_{0,63}$	4.8	3.5
$t_{0,9}$	8.6	6.6

Fundamentals of measurements:

Directive VDI/VDE 3522 sheet 1: Dynamic behaviour of contact thermometers / Principles and characteristic values

Directive VDI/VDE 3522 sheet 2 Dynamic behaviour of contact thermometers / Experimental determination of time percentage values







IEC 60751 Definition of thermal response time / Specification of measurement parameters

IEC 60751 Thermal response time

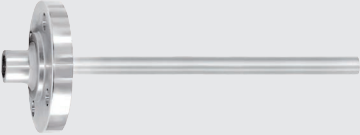
Medium to be measured: Water

Response times of thermometers in other dimensions, configurations or materials on request.

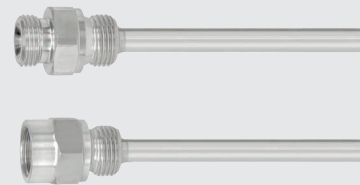
## Thermowell (option)

Thermowell selection		
Illustration	Model	Data sheet
	TW10	<ul style="list-style-type: none"> <li>■ TW 95.10</li> <li>■ TW 95.11</li> <li>■ TW 95.12</li> </ul>
	TW15	TW 95.15
	TW20	TW 95.20
	TW25	TW 95.25
	TW30	TW 95.30
	TW45	TW 95.45
	TW50	TW 95.50
	TW55	TW 95.55

Special thermowells on request.





# Approvals

## Approvals included in the scope of delivery









Logo	Description	Country
	<b>EU declaration of conformity</b>	European Union
	EMC directive <sup>1)</sup> EN 61326 emission (group 1, class B) and immunity (industrial application)	
	RoHS directive	

1) Only for built-in transmitter

## Optional approvals

Logo	Description	Country
	<b>EU declaration of conformity</b> ATEX directive Hazardous areas - Ex i Zone 0 gas II 1G Ex ia IIC T1 ... T6 Ga Zone 1 gas II 2G Ex ia IIC T1 ... T6 Gb Zone 1 mounting to zone 0 gas II 1/2G Ex ia IIC T1 ... T6 Ga/Gb Zone 20 dust II 1D Ex ia IIIC T125 ... T65 °C Da Zone 21 dust II 2D Ex ia IIIC T125 ... T65 °C Db Zone 21 mounting to zone 20 dust II 1/2D Ex ia IIIC T125 ... T65 °C Da/Db - Ex e <sup>1)</sup> Zone 1 gas II 2G Ex eb IIC T1 ... T6 Gb <sup>3)</sup> Zone 2 gas II 3G Ex ec IIC T1 ... T6 Gc X Zone 21 dust II 2D Ex tb IIIC TX °C Db <sup>3)</sup> Zone 22 dust II 3D Ex tc IIIC TX °C Dc X - Ex n <sup>1)</sup> Zone 2 gas II 3G Ex nA IIC T1 ... T6 Gc X - Ex t <sup>1)</sup> Zone 22 dust II 3D Ex tc IIIC TX °C Dc X	European Union
	<b>IECEx</b> Hazardous areas - Ex i Zone 0 gas Ex ia IIC T1 ... T6 Ga Zone 1 gas Ex ia IIC T1 ... T6 Gb Zone 1 mounting to zone 0 gas Ex ia IIC T1 ... T6 Ga/Gb Zone 20 dust Ex ia IIIC T125 ... T65 °C Da Zone 21 dust Ex ia IIIC T125 ... T65 °C Db Zone 21 mounting to zone 20 dust Ex ia IIIC T125 ... T65 °C Da/Db - Ex e <sup>2)</sup> Zone 1 gas Ex eb IIC T1 ... T6 Gb <sup>3)</sup> Zone 2 gas Ex ec IIC T1 ... T6 Gc Zone 21 dust Ex tb IIIC TX °C Db <sup>3)</sup> Zone 22 dust Ex tc IIIC TX °C Dc - Ex n <sup>2)</sup> Zone 2 gas Ex nA IIC T1 ... T6 Gc - Ex t <sup>2)</sup> Zone 22 dust Ex tc IIIC TX °C Dc	International
	<b>Ex Ukraine</b> Hazardous areas - Ex i Zone 0 gas II 1G Ex ia IIC T1 ... T6 Ga Zone 1 gas II 2G Ex ia IIC T1 ... T6 Gb Zone 1 mounting to zone 0 gas II 1/2G Ex ia IIC T1 ... T6 Ga/Gb Zone 20 dust II 1D Ex ia IIIC T65°C Da Zone 21 dust II 2D Ex ia IIIC T65°C Db Zone 21 mounting to zone 20 dust II 1/2D Ex ia IIIC T65°C Da/Db	Ukraine
	<b>INMETRO</b> Hazardous areas - Ex i Zone 0 gas Ex ia IIC T3 ... T6 Ga Zone 1 mounting to zone 0 gas Ex ia IIC T3 ... T6 Ga/Gb Zone 20 dust Ex ia IIIC T125 ... T65 °C Da Zone 21 mounting to zone 20 dust Ex ia IIIC T125 ... T65 °C Da/Db	Brazil



Logo	Description	Country
	<b>CCC</b> <sup>3)</sup> Hazardous areas - Ex i Zone 0 gas Ex ia IIC T1 ... T6 Ga Zone 1 gas Ex ia IIC T1 ... T6 Gb Zone 1 mounting to zone 0 gas Ex ia IIC T1 ... T6 Ga/Gb Zone 20 dust Ex ia IIIC T <sub>200</sub> 65°C/T <sub>200</sub> 95°C/T <sub>200</sub> 125°C Da Zone 21 dust Ex ia IIIC T65°C/T95°C/T125°C Db Zone 21 mounting to zone 20 dust Ex ia IIIC T <sub>200</sub> 65°C/T <sub>200</sub> 95°C/T <sub>200</sub> 125°C Da/Db Zone 21 dust Ex ib IIIC T65°C/T95°C/T125°C Db - Ex e <sup>2)</sup> Zone 1 gas Ex eb IIC T1 ... T6 Gb Zone 2 gas Ex ec IIC T1 ... T6 Gc	China
	<b>NEPSI</b> <sup>4)</sup> Hazardous areas - Ex i Zone 0 gas Ex ia IIC T1 ~ T6 Gb Zone 1 gas Ex ia IIC T1 ~ T6 Ga/Gb Zone 1 mounting to zone 0 gas Ex iaD 20 T65/T95/T125°C Zone 20 dust Ex iaD 21 T65/T95/T125°C Zone 21 dust Ex iaD 20/21 T65/T95/T125°C Zone 21 mounting to zone 20 dust Ex nA IIC T1 ~ T6 Gc - Ex n <sup>2)</sup> Zone 2 gas	China
	<b>KCs</b> Hazardous areas - Ex i Zone 0 gas Ex ia IIC T4 ... T6 Zone 1 gas Ex ib IIC T4 ... T6	South Korea
-	<b>PESO</b> Hazardous areas - Ex i Zone 0 gas Ex ia IIC T1 ... T6 Ga Zone 1 gas Ex ia IIC T1 ... T6 Gb Zone 1 mounting to zone 0 gas Ex ia IIC T1 ... T6 Ga/Gb	India
	<b>EAC</b> Hazardous areas - Ex i Zone 0 gas 0 Ex ia IIC T6 ... T1 Ga X Zone 1 gas 1 Ex ia IIC T6 ... T1 Gb X Zone 20 dust Ex ia IIIC T80 ... T440 °C Da X Zone 21 dust Ex ia IIIC T80...T440 °C Db X - Ex n <sup>1)</sup> Zone 2 gas 2 Ex nA IIC T6 ... T1 Gc X	Eurasian Economic Community
	<b>PAC Ukraine</b> Metrology, measurement technology	Ukraine
	<b>PAC Kazakhstan</b> Metrology, measurement technology	Kazakhstan
-	<b>MchS</b> Permission for commissioning	Kazakhstan
	<b>PAC Uzbekistan</b> Metrology, measurement technology	Uzbekistan
	<b>DNV GL</b> Type approval for the shipbuilding industry - Maximum insertion length l <sub>1</sub> : 435 mm - Connection head: Model BSZ - Neck tube: Ø 11 x 2 mm or Ø 12 x 2.5 mm, max. 150 mm long - Measuring insert: Ø 6 mm - Optional with TW10-P (see data sheets TW 95.10, TW 95.12)  <i>Location classification:</i> Temperature D (ambient temperature: -25 ... +70 °C) Humidity B (relative humidity: up to 100 %) Vibration B (frequency: 3 ... 25 Hz; amplitude: 1.6 mm peak; frequency: 25 ... 100 Hz; amplitude: 4 g) EMC Not relevant Case Required protection according to DNV rules shall be provided upon installation on board. For use on open deck a connection head IP68 is required. <sup>5)</sup> (for "open deck")	International

1) Only for connection head model BSZ, BSZ-H, 1/4000, 5/6000 or 7/8000 (see "Connection head")

2) Only with connection head, model 1/4000, 5/6000 or 7/8000 (see "Connection head")

3) Only without transmitter

4) Only with transmitter

5) Suitable cable gland required

Instruments marked with “ia” may also be used in areas only requiring instruments marked with “ib” or “ic”. If an instrument with “ia” marking has been used in an area with requirements in accordance with “ib” or “ic”, it can no longer be operated in areas with requirements in accordance with “ia” afterwards.



### Explosion protection (option)

The permissible power,  $P_{max}$ , as well as the permissible ambient temperature, for the respective category can be seen on the Ex certificate or the operating instructions.

The transmitter have their own certificates for hazardous

areas. The permissible ambient temperature ranges of the built-in transmitters can be taken from the corresponding transmitter operating instructions and approvals.

## Manufacturer's information and certificates

Logo	Description
	<b>SIL 2, SIL 3</b> see page 10 Functional safety
	<b>NAMUR NE 024</b> Hazardous areas (Ex i)

## Certificates (option)

Certification type	Measurement accuracy	Material certificate <sup>1)</sup>
<b>2.2 test report</b>	x	x
<b>3.1 inspection certificate</b>	x	x
<b>DAkkS calibration certificate</b>	x	-

1) Thermowells have their own material certificates for selected components

For calibration, the measuring insert is removed from the thermometer. The minimum length (metal part of the probe) for carrying out a 3.1 measurement accuracy test or DAkkS is 100 mm [~ 4 in].

Calibration of shorter lengths as well as calibration of versions in 2-wire connection possible on request.

The different certifications can be combined with each other.

→ For approvals and certificates, see website

# Dimensions

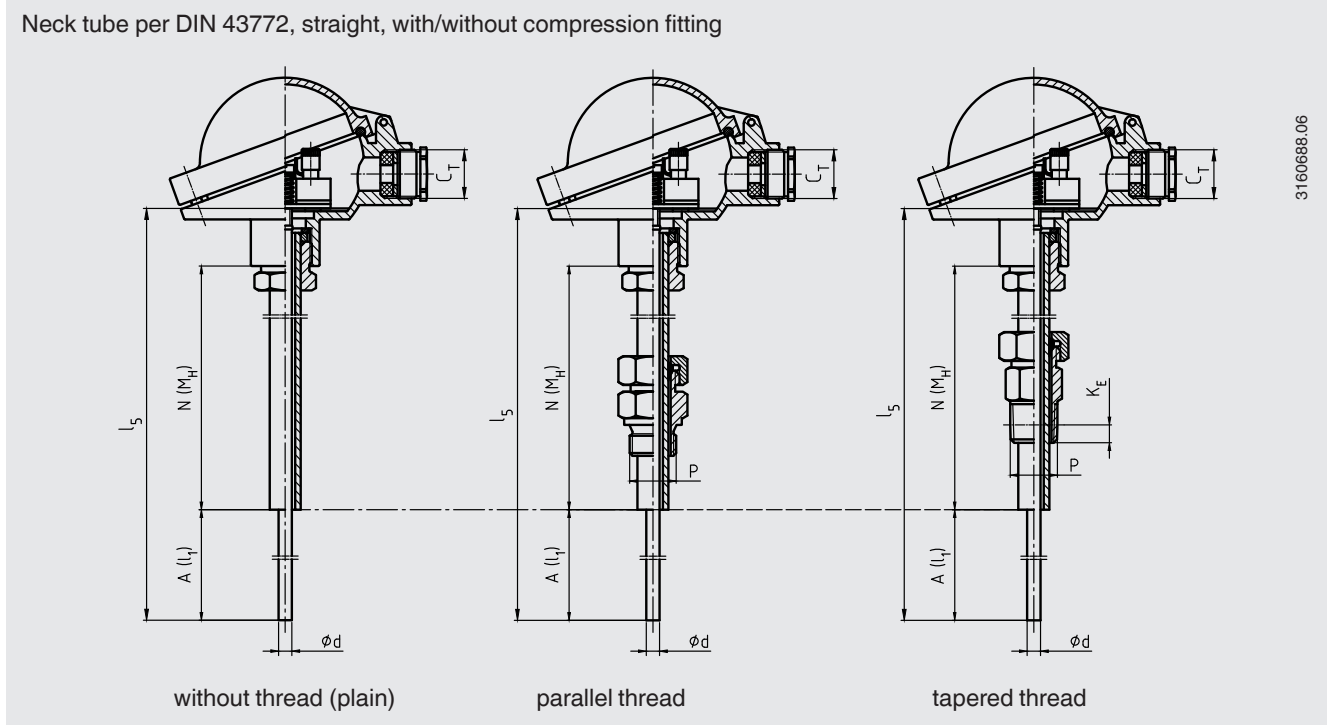
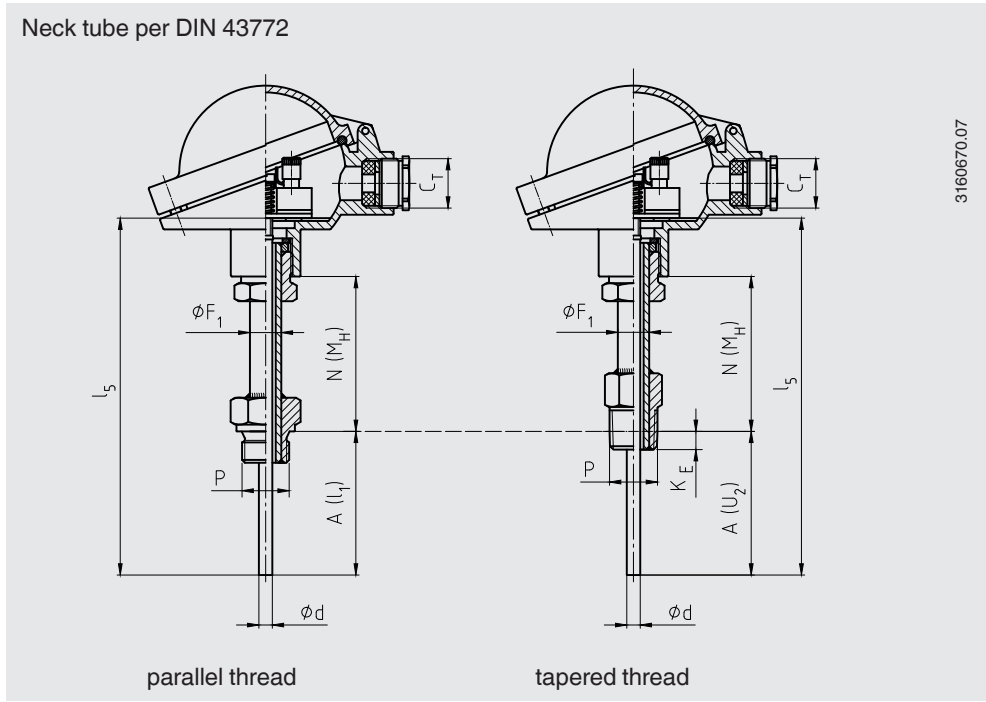

**Legend:**

- |           |  |            |                           |
|-----------|--|------------|---------------------------|
| $A (I_1)$ | Insertion length (parallel threads)  | $C_T$      | Thread cable inlet        |
| $A (U_2)$ | Insertion length (tapered threads)   | $\phi F_1$ | Neck tube diameter        |
| $l_5$     | Measuring insert length  | $P$        | Thread to the thermowell  |
| $N (M_H)$ | Neck length  | $\phi d$   | Measuring insert diameter |
| $K_E$     | $\frac{1}{2}$ NPT: 8.13 mm [0.320 in]<br>$\frac{3}{4}$ NPT: 8.61 mm [0.339 in] |            |                           |

The figures show examples of connection heads.

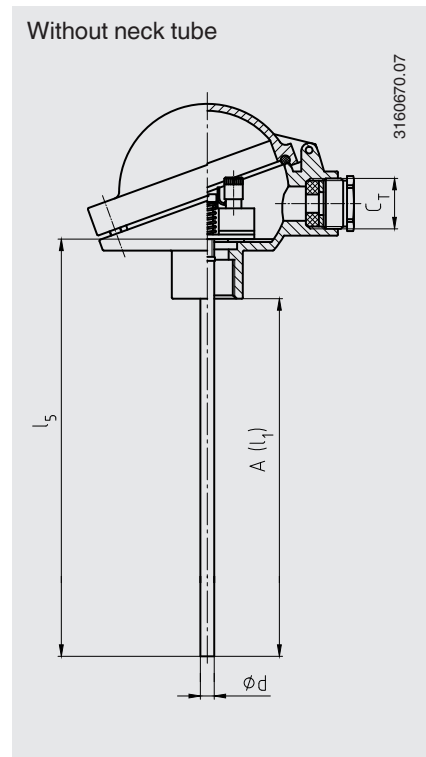
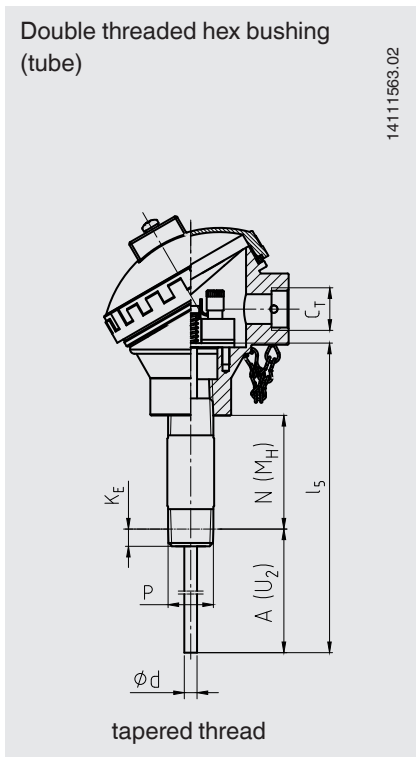
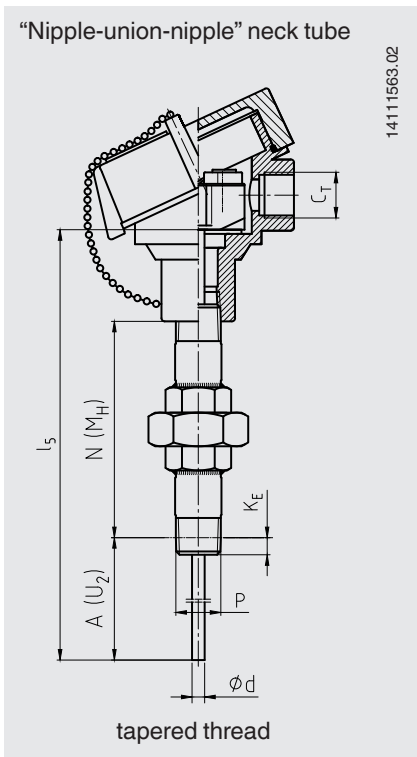
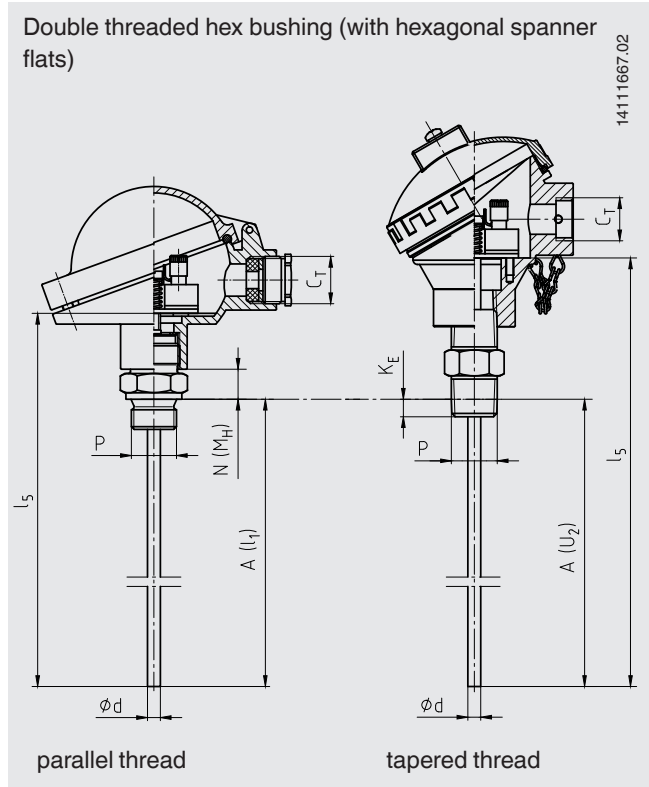
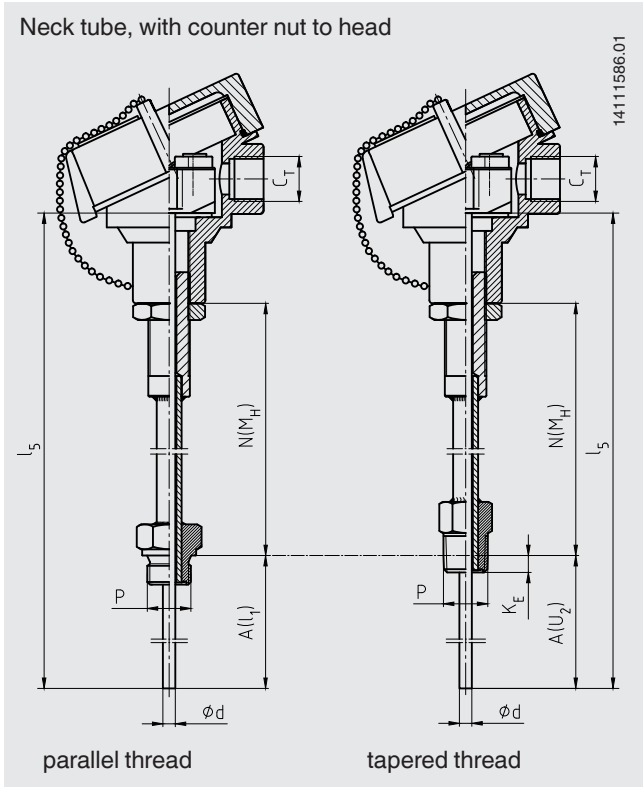

Legend:

- A (l<sub>1</sub>) Insertion length (parallel threads)
- A (U<sub>2</sub>) Insertion length (tapered threads)
- l<sub>5</sub> Measuring insert length
- N (M<sub>H</sub>) Neck length
- K<sub>E</sub> ½ NPT: 8.13 mm [0.320 in]  
¾ NPT: 8.61 mm [0.339 in]

- C<sub>T</sub> Thread cable inlet
- Ø F<sub>1</sub> Neck tube diameter
- P Thread to the thermowell
- Ø d Measuring insert diameter

The figures show examples of connection heads.

### Ordering information

Model / Explosion protection / Further approvals, certificates / Sensor / Accuracy class, range of use of the sensor / Connection housing / Cable inlet / Transmitter / Connection to neck tube / Neck tube / Thread size / Neck length N (MH) / Insertion length A (I1), A (U2) / Measuring insert diameter  $\varnothing$  d / Measuring insert sheath material / Certificates / Options

© 04/2003 WIKA Alexander Wiegand SE & Co. KG, all rights reserved.  
The specifications given in this document represent the state of engineering at the time of publishing.  
We reserve the right to make modifications to the specifications and materials.



**WIKA Alexander Wiegand SE & Co. KG**  
Alexander-Wiegand-Straße 30  
63911 Klingenberg/Germany  
Tel. +49 9372 132-0  
info@wika.de  
www.wika.de