

# Absolute pressure gauge with output signal

## For the process industry, NS 100 and 160

### Model APGT43

WIKA data sheet PV 15.02



for further approvals see  
page 5

**intelliGAUGE®**

### Applications

- Acquisition and display of processes
- Output signals 4 ... 20 mA, 0 ... 20 mA, 0 ... 10 V for the transmission of process values to the control room
- Pressure measurement independent of fluctuations in the atmospheric pressure
- Monitoring of vacuum pumps and packaging machines
- Measurement of condensation pressures and determination of vapour pressure in liquids

### Special features

- No configuration necessary due to "plug-and-play"
- Scale ranges from 0 ... 25 mbar absolute pressure
- Easy-to-read analogue display with nominal sizes 100 and 160
- High overload safety, long service life due to metal media chamber sealing
- Media chamber protected against unauthorised access

**intelliGAUGE® model APGT43**

### Description

The model APGT43 intelliGAUGE® (patent, property right: e.g. DE 202007019025) can be used wherever pressure measurement has to be independent of fluctuations in the atmospheric pressure. The instrument serves for the on-site display with a simultaneous signal transmission to a central control or remote centre.

The model APGT43 is based upon a model 532.54 high-quality, stainless steel pressure gauge, manufactured in accordance with DIN 16002.

The intelliGAUGE® model APGT43 fulfils all safety-related requirements of the relevant standards and regulations for the on-site display of the working pressure of pressure vessels.

The robust diaphragm measuring system produces a pointer rotation proportional to the pressure.

An electronic angle encoder, proven in safety-critical automotive applications, determines the position of the pointer shaft – it is a non-contact sensor and therefore completely free from wear and friction. From this, the electrical output signal proportional to the pressure, e.g. 4 ... 20 mA, is produced. The measuring span (electrical output signal) is adjusted automatically along with the mechanical display, i.e. the scale over the full display range corresponds to 4 ... 20 mA. The electrical zero point can also be set manually.

The electronic WIKA sensor, integrated into the high-quality absolute pressure gauge, combines the advantages of electrical signal transmission with a local mechanical display that remains readable during a power failure.

An additional measuring point for mechanical pressure display can thus be saved.

## Specifications

Model APGT43	
<b>Design</b>	Mechanical absolute pressure measuring instrument per DIN 16002
<b>Nominal size in mm</b>	<ul style="list-style-type: none"> <li>■ 100</li> <li>■ 160</li> </ul>
<b>Accuracy class</b>	2.5 Option: 1.6 <sup>1)</sup> The measurement accuracy is ensured for ambient pressure fluctuations between 955 and 1,065 mbar (min. and max. of atmospheric pressure)
<b>Scale ranges</b>	0 ... 25 mbar to 0 ... 25 bar absolute pressure [0 ... 0.36 psi to 0 ... 3,600 psi absolute pressure]
<b>Scale</b>	Single scale Option: Dual scale
<b>Pressure limitation</b>	
Steady	Full scale value
Fluctuating	0.9 x full scale value
<b>Overload safety</b>	10 x full scale value, max. 25 bar absolute pressure, min. 1 bar absolute pressure Option: 20 x full scale value, max. 25 bar absolute pressure, min. 1 bar absolute pressure
<b>Process connection with lower measuring flange</b>	<ul style="list-style-type: none"> <li>■ G ½ B</li> <li>■ ½ NPT</li> <li>■ ½ NPT female</li> <li>■ Open connecting flange DN 25 PN 25 per EN 1092-1, form B</li> <li>■ Open connecting flange DN 25 PN 25, DIN 2501, form D per DIN 2526</li> <li>■ Small flange for vacuum applications DN 10</li> <li>■ Small flange for vacuum applications DN 16</li> </ul> Further threaded connections and open connecting flanges on request
<b>Permissible temperature</b> <sup>2)</sup>	
Medium	+100 °C [+212 °F] maximum Option: +200 °C [+392 °F] maximum
Ambient	-20 ... +60 °C [-4 ... 140 °F] Option: -40 ... +60 °C (silicone oil filling) <sup>1)</sup>
<b>Temperature effect</b>	When the temperature of the measuring system deviates from the reference temperature (+20 °C): max. ±0.8 %/10 K of full scale value
<b>Case</b>	Safety version S3 per EN 837: With solid baffle wall (Solidfront) and blow-out back Instruments with liquid filling with compensating valve to vent case
<b>Case filling</b>	Without Option: With silicone oil M50 case filling, ingress protection IP65
<b>Wetted materials</b>	
Diaphragm element (pressure element)	≤ 0.25 bar: Stainless steel 316Ti > 0.25 bar: NiCr alloy (Inconel)
Media chamber with process connection	Stainless steel 316L
	Option: Wetted parts from Monel <sup>1)</sup>

1) Application test required

2) For hazardous areas, the permissible temperatures of the output signal variant 2 will apply exclusively (see page 4). These must not be exceeded at the instrument either (for details see operating instructions). If necessary, measures for cooling (e.g. syphon, instrumentation valve, etc.) have to be taken.

Model APGT43	
<b>Non-wetted materials</b>	
Case, movement, bayonet ring	Stainless steel
Dial	Aluminium, white, black lettering
Instrument pointer	Aluminium, black
Set pointer	Aluminium, red
Window	Laminated safety glass
<b>Ingress protection per IEC/EN 60529</b>	IP54 Option: IP65
<b>Mounting</b>	Rigid measuring lines Option: ■ Panel or surface mounting flange ■ Instrument mounting bracket for wall or pipe mounting

## Design and operating principle

- The diaphragm (1) separates the media chamber (3) and the reference pressure chamber (2) with absolute pressure zero
- Pressure differential between media chamber (3) and reference pressure chamber (2) will deflect the diaphragm (1)
- In case of an overpressure overload the pressure element will be protected by a contoured metal bolster
- The deflection is transferred from the pressure chambers through bellows or corrugated tubes (4), transmitted to the movement via the link (5) and indicated

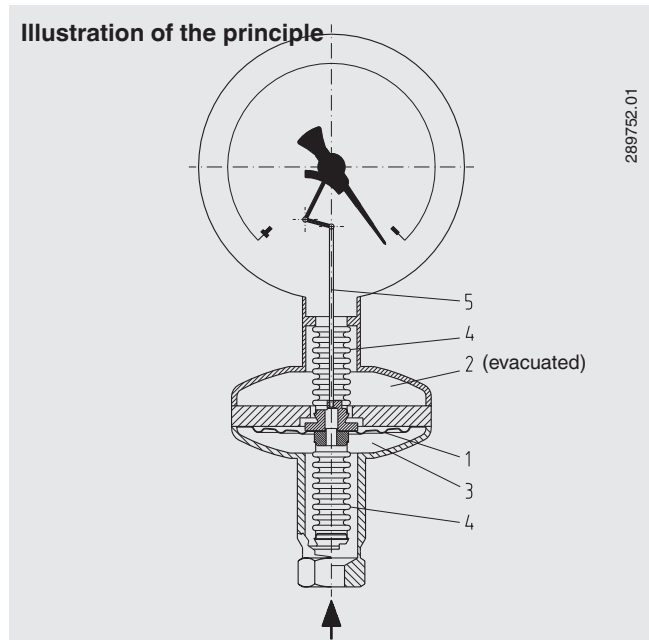

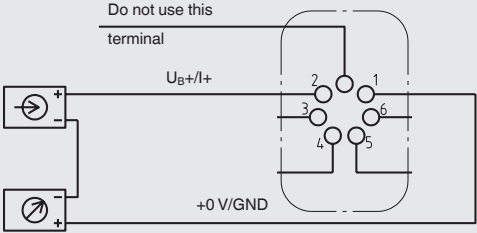
Model APT43	
<b>Output signal</b>	Variant 1: 4 ... 20 mA, 2-wire, passive, per NAMUR NE 43 Variant 2: 4 ... 20 mA, 2-wire, for hazardous areas Variant 3: 0 ... 20 mA, 3-wire Variant 4: 0 ... 10 V, 3-wire
<b>Supply voltage <math>U_B</math></b>	DC 12 V < $U_B$ ≤ 30 V (variant 1 and 3) DC 14 V < $U_B$ ≤ 30 V (variant 2) DC 15 V < $U_B$ ≤ 30 V (variant 4)
<b>Influence of supply voltage</b>	≤ 0.1 % of full scale/10 V
<b>Permissible residual ripple of <math>U_B</math></b>	≤ 10 % ss
<b>Permissible max. load <math>R_A</math></b>	Variant 1, 2, 3: $R_A \leq (U_B - 12 \text{ V})/0.02 \text{ A}$ with $R_A$ in $\Omega$ and $U_B$ in V, however max. 600 $\Omega$ Variant 4: $R_A = 100 \text{ k}\Omega$
<b>Effect of load (variant 1, 2, 3)</b>	≤ 0.1 % of full scale
<b>Impedance at voltage output</b>	0.5 $\Omega$
<b>Electrical zero point</b>	Through a jumper across terminals 5 and 6 (see operating instructions)
<b>Long-term stability of electronics</b>	< 0.3 % of full scale per year
<b>Electr. output signal</b>	≤ 1 % of measuring span
<b>Linear error</b>	≤ 1 % of measuring span (terminal method)
<b>Resolution</b>	0.13 % of full scale (10 bit resolution at 360°)
<b>Refresh rate (measuring rate)</b>	600 ms
<b>Electrical connection</b>	Cable socket PA 6, black Per VDE 0110 insulation group C/250 V Cable gland M20 x 1.5 Strain relief 6 screw terminals + PE for conductor cross-section 2.5 mm <sup>2</sup>
<b>Designation of connection terminals, 2-wire (variant 1 and 2)</b>	 <p>Do not use this terminal</p> <p><math>U_B+/I+</math></p> <p>+0 V/GND</p> <p>Terminals 3 and 4: For internal use only Terminals 5 and 6: Reset zero point</p>
Designation of connection terminals for 3-wire (variant 3 and 4), see operating instructions	

### Safety-related maximum values (variant 2)

$U_i$	$I_i$	$P_i$	$C_i$	$L_i$
DC 30 V	100 mA	720 mW	11 nF	negligible









### Permissible temperature ranges (variant 2)

T6	T5	T4 ... T1
-20 ... +45 °C	-20 ... +60 °C	-20 ... +70 °C

T85°C	T100°C	T135°C
-20 ... +45 °C	-20 ... +60 °C	-20 ... +70 °C

For further information on hazardous areas, see operating instructions.

## Approvals

Logo	Description	Country
	<b>EU declaration of conformity</b> <ul style="list-style-type: none"> <li>■ EMC directive</li> <li>■ Pressure equipment directive</li> <li>■ RoHS directive</li> <li>■ ATEX directive (option)</li> </ul> Hazardous areas - Ex ia Gas [II 2G Ex ia IIC T6/T5/T4 Gb] Dust [II 2D Ex ia IIIB T85°C/T100°C/T135°C Db]	European Union
	<b>IECEx (option)</b> Hazardous areas - Ex ia Gas [Ex ia IIC T6/T5/T4 Gb] Dust [Ex ia IIIB T85°C/T100°C/T135°C Db]	International
	<b>EAC (option)</b> <ul style="list-style-type: none"> <li>■ EMC directive</li> <li>■ Pressure equipment directive</li> <li>■ Low voltage directive</li> <li>■ Hazardous areas</li> </ul>	Eurasian Economic Community
	<b>GOST (option)</b> Metrology, measurement technology	Russia
	<b>KazInMetr (option)</b> Metrology, measurement technology	Kazakhstan
-	<b>MTSCHS (option)</b> Permission for commissioning	Kazakhstan
	<b>UkrSEPRO (option)</b> Metrology, measurement technology	Ukraine
	<b>DNOP (MakNII) (option)</b> Hazardous areas	Ukraine
	<b>Uzstandard (option)</b> Metrology, measurement technology	Uzbekistan
-	<b>CRN</b> Safety (e.g. electr. safety, overpressure, ...)	Canada

## Certificates (option)

- 2.2 test report per EN 10204 (e.g. state-of-the-art manufacturing, indication accuracy)
- 3.1 inspection certificate per EN 10204 (e.g. indication accuracy)

## Patents, property rights

Pointer measuring instrument with output signal 4 ...  
 20 mA (patent, property right: e.g. DE 202007019025,  
 US 2010045366, CN 101438333)

Approvals and certificates, see website

## Accessories

- Sealings (model 910.17, see data sheet AC 09.08)
- Valves (models IV20/IV21, see data sheet AC 09.19, and models IV10/IV11, see data sheet AC 09.22)
- Syphons (model 910.15, see data sheet AC 09.06)
- Switch contacts (see data sheet AC 08.01)

# Dimensions in mm

## intelliGAUGE® model APGT43

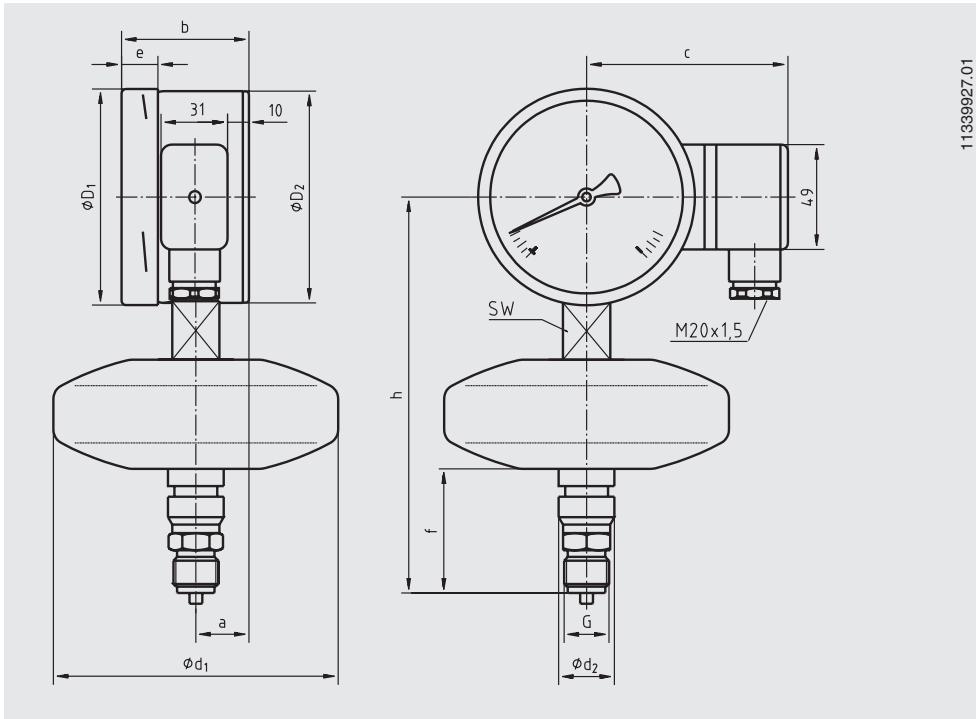

NS	Scale range	Dimensions in mm											Weight in kg	
	in bar	a	b	c	d <sub>1</sub>	d <sub>2</sub>	D <sub>1</sub>	D <sub>2</sub>	e	f	G	h ±1		SW
100	≤ 0 ... 250 mbar	25	59.5	94	133	26	101	99	17	58	G ½ B	185	22	1.8
100	> 0 ... 250 mbar	25	59.5	94	76	26	101	99	17	66	G ½ B	177	22	1.2
160	≤ 0 ... 250 mbar	25	65	124	133	26	161	159	17	58	G ½ B	215	22	2.3
160	> 0 ... 250 mbar	25	65	124	76	26	161	159	17	66	G ½ B	207	22	1.6

Process connection per EN 837-3/7.3

### Ordering information

Model / Nominal size / Scale range / Output signal / Connection location / Process connection / Options

© 09/2008 WIKA Alexander Wiegand SE & Co. KG, all rights reserved.  
The specifications given in this document represent the state of engineering at the time of publishing.  
We reserve the right to make modifications to the specifications and materials.

