

Programming of
D-20-9/D-21-9

Pressure transmitter with
CANopen Interface

CANopen



D-20-9



D-20-9
with integrated
Y-Piece



D-21-9
with DIP-switch



This instruction only contains additional information about the programming of D-20-9/D-21-9 CANopen pressure transmitter. For the standard information please refer to operating instructions No. 2059064.

Operating instruction (No. 2059064)

Download version



Printed version

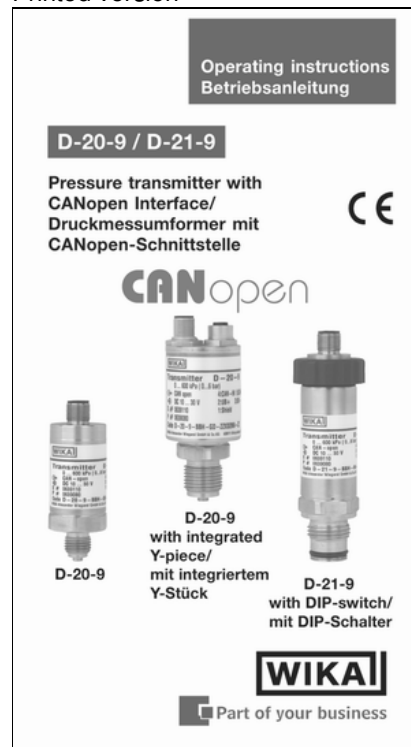

WIKAL Alexander Wiegand GmbH & Co. KG

Alexander-Wiegand-Straße 30
63911 Klingenberg / Germany
Tel. (+49) 93 72/132-6108
Fax (+49) 93 72/132-706
E-Mail support-tronic@wika.de
www.wika.de

2092169.03 GB 01/2006

Content

1. Process Data Object (PDO).....	5
Data Types	5
Change of PDO-Mapping:.....	6
PDO Transmission Types (Object 1800h, subindex 2).....	6
2. Service Data Object (SDO).....	7
Read Object	7
Write Object.....	7
Abort SDO Transfer.....	7
Abort Codes	7
3. Object Dictionary – Communication Profile Area	8
1000h Device Type	8
1001h Error Register	8
1005h COB-ID SYNC message	9
1008h Manufacturer Device Name	9
1009h Manufacturer Hardware Version	10
100Ah Manufacturer Software Version	10
100Ch Guard Time.....	11
100Dh Life Time Factor.....	11
1010h Store Parameters	12
1011h Restore Default Parameters.....	13
1014h COB-ID Emergency Object	14
1017h Producer Heartbeat Time.....	14
1018h Identity Object	15
1800h Transmit PDO Communication Parameter	16
1A00h Transmit PDO Mapping Parameter	17
4. Object Dictionary – Manufacturer Specific Area.....	18
2010h Minimum allowed Pressure	18
2011h Maximum allowed Pressure	18
2020h Min. Value Storage.....	19
2021h Max. Value Storage.....	19
2090h Process Value as Integer	20
2100h User Device Name	20
2201h Last Calibration Date Year	21
2202h Last Calibration Date Month.....	21
2203h Last Calibration Date Day	21
2207h Date of Production Year.....	22
2208h Date of Production Month	22
2209h Date of Production Day	22
2320h Configure Node-ID	23
2321h Configure Bit Timing.....	23
2330h Auto-Operational	24
5. Object Dictionary – Device Profile Area	25
6110h AI Sensor Type.....	25
6114h AI ADC Sample Rate.....	25
7100h AI Input FV	26
7120h AI Input Scaling 1 FV	27

6121h AI Input Scaling 1 PV	27
7122h AI Input Scaling 2 FV	28
6123h AI Input Scaling 2 PV	28
6124h AI Input Offset	29
6125h AI Autozero.....	29
6130h AI Input PV	30
6131h AI Physical Unit PV	30
6132h AI Decimal Digits.....	31
6148h AI Span Start.....	31
6149h AI Span End	32
61A0h AI Filter Type.....	33
61A1h AI Filter Constant	33
6. Calibration.....	34
Input Scaling.....	34
Input Offset.....	36
Input Autozero	36
7. Filter	37
8. Emergency Object (EMCY)	38
9. Network Management Objects	39
Module Control Services	39
Error Control Services.....	41
Bootup Service	43
10. Layer Setting Services (LSS).....	44
LSS Address	44
Switch Mode Services.....	44
Configuration Services	44
LSS Protocol Descriptions.....	45
Example.....	49
11. References.....	49
12. Definitions and abbreviations.....	50
13. History.....	50

1. Process Data Object (PDO)

ID	DLC	Byte0	Byte1	Byte2	Byte3
ID	4	LSB MSB process value			

The structure of the synchronous and asynchronous PDO is identical.
 The identifier of the PDO can be set via object 1800h.
 Factory-set: 180h + NID

Byte 0 to byte 3 contains the currently configured process value.

The default settings are configured to object 2090h subindex 0 (process value as integer).
 The coding corresponds to DS301, chapter 9.1.4.5 "Signed Integer"

The user can switch the mapping to object 6130h subindex 1 (process value as float).
 Then the coding corresponds to DS301, chapter 9.1.4.6 "Floating Point Numbers"

For further information about the data types see description below.

Data Types

Signed Integer

	Byte0	Byte1	Byte2	Byte3
Integer32	b _{7..b₀}	b _{15..b₈}	b _{23..b₁₆}	b _{31..b₂₄}

The data is represented as bit sequence of length 32.

The bit sequence $b = b_0 .. b_{31}$ is assigned the value

$$\text{INTEGER32}(b) = b_{30} * 2^{30} + \dots + b_1 * 2^1 + b_0 * 2^0 \quad \text{if } b_{31}=0$$

and, performing two's complement arithmetic,

$$\text{INTEGER32}(b) = - \text{INTEGER32}(\text{^}b) - 1 \quad \text{if } b_{31}=1$$

Floating Point Numbers

	Byte0	Byte1	Byte2	Byte3
Real32	b _{7..b₀}	b _{15..b₈}	b _{23..b₁₆}	b _{31..b₂₄}

The data type *REAL32* is represented as bit sequence of length 32.

The encoding of values follows the IEEE 754-1985 Standard for single precision floating-point.

The bit sequence $b = b_0 .. b_{31}$ is assigned the value

$$\text{REAL32}(b) = (-1)^S * 2^{E-127} * (1+F)$$

Here

$S = b_{31}$ is the sign.

$E = b_{30} * 2^7 + \dots + b_{23} * 2^0$; $0 < E < 255$; is the un-biased exponent.

$F = 2^{-23} * (b_{22} * 2^{22} + \dots + b_1 * 2^1 + b_0 * 2^0)$ is the fractional part of the number.

Change of PDO-Mapping:

- the device has to be in the PRE-OPERATIONAL mode
- deactivate currently mapped object by writing 0 to object 1A00h subindex 0
- mapping is deactivated, PDO does not supply any data; DLC = 0
- Write desired object to subindex 1 of object 1A00h (INTEGER32: 2090 00 20h / REAL32: 6130 01 20)
- Finally the mapping has to be reactivated by writing 1 to object 1A00h subindex 0

The physical unit of the process value can be configured via object 6131h "Physical Unit Process Value"

The decimal digits can be changed via object 6132h "AI Decimal Digits"

PDO Transmission Types (Object 1800h, subindex 2)

Synchronous Transmission:

A transmission type of n (1 ... 240) means that the message is transmitted with every n-th SYNC object.

Asynchronous Transmission:

A transmission type of 253 means that the message will be sent after a RTR.

A transmission type of 254 means that the message will be sent after the event timer elapses. The **event timer** can be configured via object 1800h subindex 5.

2. Service Data Object (SDO)

With Service Data Objects the access to entries of a device's object dictionary is provided.

Read Object

Master sends

ID	DLC	Byte0	Byte1	Byte2	Byte3	Byte4	Byte5	Byte6	Byte7
600h + Node-ID	8	CS = 40h	LSB Index	MSB	Sub- Index	00h	00h	00h	00h

Transmitter answers

ID	DLC	Byte0	Byte1	Byte2	Byte3	Byte4	Byte5	Byte6	Byte7
580h + Node-ID	8	CS = 42h	LSB Index	MSB	Sub- Index	LSB Data			MSB

Write Object

Master sends

ID	DLC	Byte0	Byte1	Byte2	Byte3	Byte4	Byte5	Byte6	Byte7
600h + Node-ID	8	CS = 22h	LSB Index	MSB	Sub- Index	LSB Data			MSB

Transmitter answers

ID	DLC	Byte0	Byte1	Byte2	Byte3	Byte4	Byte5	Byte6	Byte7
580h + Node-ID	8	CS = 60h	LSB Index	MSB	Sub- Index	00h	00h	00h	00h

Abort SDO Transfer

If an error occurred while reading or writing an object, the transmitter answers:

ID	DLC	Byte0	Byte1	Byte2	Byte3	Byte4	Byte5	Byte6	Byte7
580h + Node-ID	8	CS = 80h	LSB Index	MSB	Sub- Index	LSB Abort Code			MSB

Abort Codes

0504 0001h	Client/server command specifier not valid or unknown
0601 0001h	Attempt to read a write only object
0601 0002h	Attempt to write a read only object
0602 0000h	Object does not exist in the object dictionary
0606 0000h	Access failed due to an hardware error
0609 0011h	Sub-index does not exist
0609 0030h	Value range of parameter exceeded
0800 0020h	Data cannot be transferred or stored to the application

3. Object Dictionary – Communication Profile Area

(according CiA DS301 V4.02)

1000h Device Type

Object description

This object describes the type of device and its functionality. It is composed of a 16-bit field which describes the device profile that is used and a second 16-bit field which gives additional information about optional functionality of the device. The additional information parameter specifies the implemented function blocks.

Entry description

Access	ro
PDO Mapping	No
Data Type	UNSIGNED 32
Default Value	0002 0194h

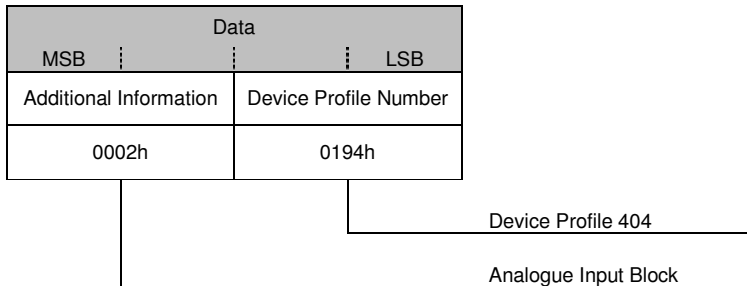

1001h Error Register

Object description

This object is an error register for the device. The device maps internal errors in this byte. It is a part of an emergency object.

Entry description

Access	ro
PDO Mapping	No
Data Type	UNSIGNED 8
Default Value	00h

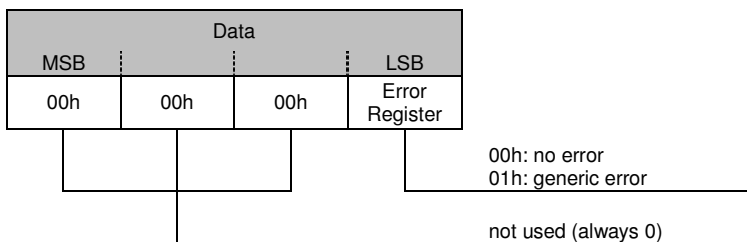

1005h COB-ID SYNC message

Object description

This Index defines the COB-ID of the Synchronisation Object (SYNC).

Entry description

Access	rw (FW-Rev. V00.08 and greater)
PDO Mapping	No
Data Type	UNSIGNED 32
Default Value	00 00 00 80h

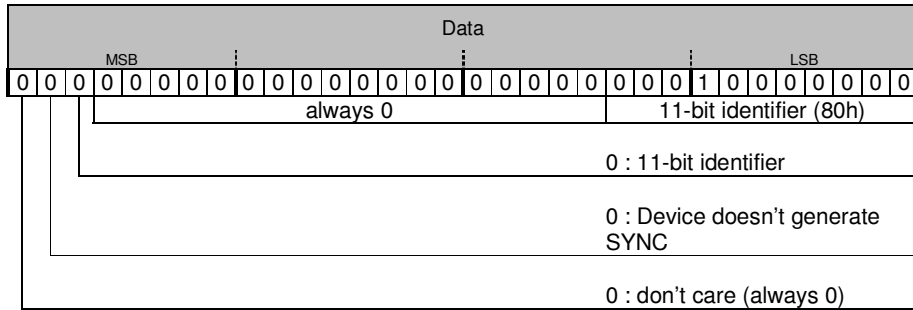

Write access only for software revision 00.08 or greater.

If the user changes the COB-ID of the SYNC message, he has to ensure that there are no conflicts to other CANopen functions, since all values between 0 and 7FFh are accepted.

If the value is greater than 7FFh an SDO-Abort-Message is generated (VALUE_RANGE_OF_PARAMETER_EXCEEDED) and the COB-ID will not be changed.

Changed parameters are not automatically stored, but they have to be stored via object 1010h Store Parameters.

Furthermore the device can be reset to the factory settings via object 1011h Restore Default Parameters.

1008h Manufacturer Device Name

Object description

Contains the manufacturer device name.

Entry description

Access	ro
PDO Mapping	No
Data Type	Visible String
Default Value	"D2X9"

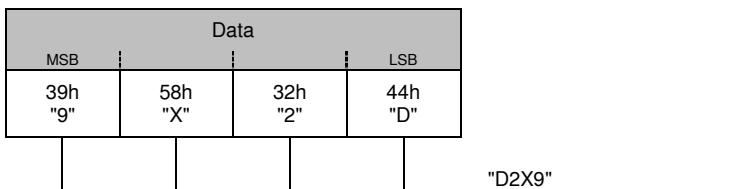

1009h Manufacturer Hardware Version

Object description

Contains the manufacturer hardware version description.

Entry description

Access	ro
PDO Mapping	No
Data Type	Visible String
Default Value	No

Data			
MSB			LSB
z	y	x	w

Byte 4-7 contain the hardware version: wx.yz

100Ah Manufacturer Software Version

Object description

Contains the manufacturer software version description.

Entry description

Access	ro
PDO Mapping	No
Data Type	Visible String
Default Value	No

Data			
MSB			LSB
z	y	x	w

Byte 4-7 contain the software version: wx.yz

100Ch Guard Time

Object description

The objects at index 100Ch and 100Dh include the guard time in milliseconds and the life time factor. The life time factor multiplied with the guard time gives the life time for the Life Guarding Protocol. It is 0 if not used.

Entry description

Access	rw*
PDO Mapping	No
Data Type	UNSIGNED 16
Default Value	0

* Write access to this object is only allowed, if object 1017h producer heartbeat time is 0. Otherwise an SDO abort message is generated (GENERAL_ERROR).

Changed parameters are not automatically stored, but they have to be stored via object 1010h Store Parameters.
Furthermore the device can be reset to the factory settings via object 1011h Restore Default Parameters.

Data		
MSB		LSB
00h	00h	Guard Time in ms

100Dh Life Time Factor

Object description

The life time factor multiplied with the guard time gives the life time for the node guarding protocol. It is 0 if not used.

Entry description

Access	rw*
PDO Mapping	No
Data Type	UNSIGNED 8
Default Value	0

* Write access to this object is only allowed, if object 1017h producer heartbeat time is 0. Otherwise an SDO abort message is generated (GENERAL_ERROR).

Changed parameters are not automatically stored, but they have to be stored via object 1010h Store Parameters.
Furthermore the device can be reset to the factory settings via object 1011h Restore Default Parameters.

Data			
MSB			LSB
00h	00h	00h	Life Time Factor

1010h Store Parameters

Object description

This object supports the saving of parameters in non volatile memory. By read access the device provides information about its saving capabilities.

Entry description

Sub-Index	00h
Name	number of entries
Access	ro
PDO Mapping	No
Data Type	UNSIGNED 8
Default Value	01h

Sub-Index	01h
Name	save all parameters
Access	rw
PDO Mapping	No
Data Type	UNSIGNED 32
Default Value	01h

In order to avoid storage of parameters by mistake, storage is only executed when the signature "save" is written to Subindex 1.

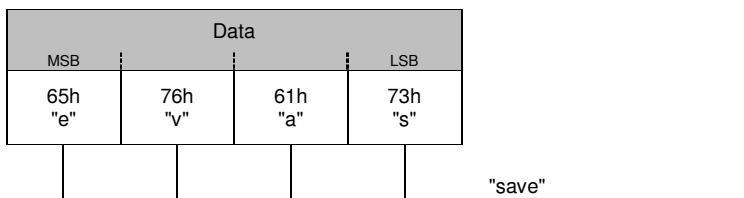

On reception of the correct signature in sub-index 1 the device stores the parameter and then confirms the SDO transmission (initiate download response). If the storing failed, the device responds with an Abort SDO Transfer (abort code: 0606 0000h). If a wrong signature is written, the device refuses to store and responds with Abort SDO Transfer (abort code: 0800 0020h).

On read access to Sub-Index 1 the device provides information about its storage functionality with the following format:

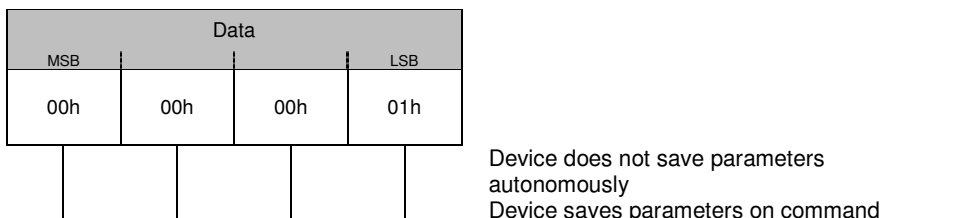

The Storage affects the following objects:

1005h	COB-ID Sync	2330h	Auto-Operational
100Ch	Guard Time	6114h	AI ADC Sample Rate
100Dh	Life Time Factor	6121h	AI Input Scaling 1 PV
1017h	Producer Heartbeat Time	6123h	AI Input Scaling 2 PV
1800h	Transmit PDO Communication Parameters	6124h	Input Offset
1A00h	Transmit PDO Mapping Parameter	6131h	AI Physical Unit PV
2010h	Minimum Allowed Pressure	6132h	Decimal Digits
2011h	Maximum Allowed Pressure	61A1h	AI Filter Constant

1011h Restore Default Parameters

Object description

With this object the default values of parameters according to the communication and device profile are restored. By read access the device provides information about its capabilities to restore these values.

Entry description

Sub-Index	00h
Name	number of entries
Access	ro
PDO Mapping	No
Data Type	UNSIGNED 8
Default Value	01h

Sub-Index	01h
Name	restore all default parameters
Access	rw
PDO Mapping	No
Data Type	UNSIGNED 32
Default Value	01h

In order to avoid the restoring of default parameters by mistake, restoring is only executed when the signature "load" is written to sub-index 1.

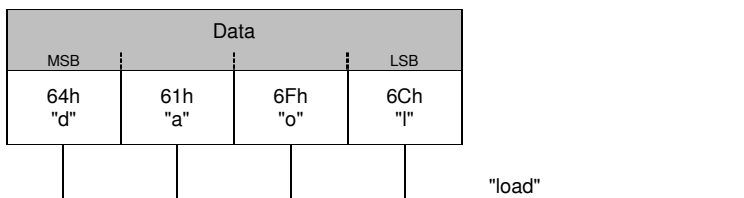

On reception of the correct signature in sub-index 1 the device restores the default parameters and then confirms the SDO transmission (initiate download response). If the restoring failed, the device responds with an Abort SDO Transfer (abort code: 0606 0000h). If a wrong signature is written, the device refuses to restore the defaults and responds with an Abort SDO Transfer (abort code: 0800 0020h). The default values are set valid after the device is reset (reset node or power cycled)

On read access to sub-index 1 the device provides information about its default parameter restoring capability with the following format:

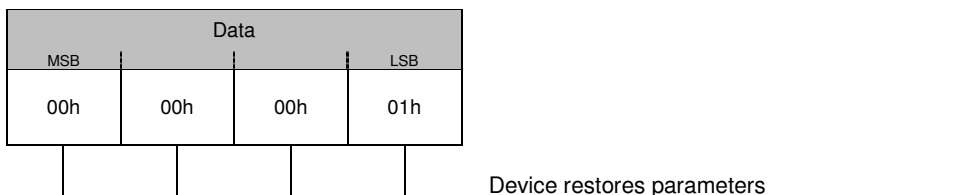

The restore affects the following objects:

1005h	COB-ID Sync	2330h	Auto-Operational
100Ch	Guard Time	6114h	AI ADC Sample Rate
100Dh	Life Time Factor	6121h	AI Input Scaling 1 PV
1017h	Producer Heartbeat Time	6123h	AI Input Scaling 2 PV
1800h	Transmit PDO Communication Parameters	6124h	Input Offset
1A00h	Transmit PDO Mapping Parameter	6131h	AI Physical Unit PV
2010h	Minimum Allowed Pressure	6132h	Decimal Digits
2011h	Maximum Allowed Pressure	61A1h	AI Filter Constant

1014h COB-ID Emergency Object

Object description

This Index defines the COB-ID of the Emergency Object (EMCY).

Entry description

Access	ro
PDO Mapping	No
Data Type	UNSIGNED 32
Default Value	80h + Node-ID

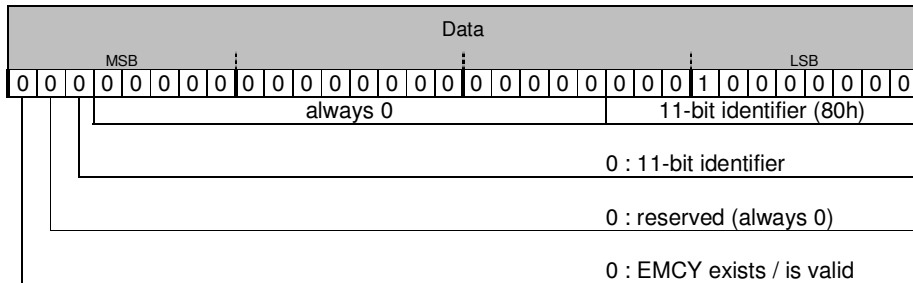

1017h Producer Heartbeat Time

Object description

The producer heartbeat time defines the cycle time of the heartbeat in milliseconds. The producer heartbeat time is 0 if it is not used.

Entry description

Access	rw*
PDO Mapping	No
Data Type	UNSIGNED 16
Default Value	0

* Write access to this object is only allowed, if object 100Ch Guard Time and 100Dh Life Time Factor are 0. Otherwise an SDO abort message is generated (GENERAL_ERROR).

Changed parameters are not automatically stored, but they have to be stored via object 1010h Store Parameters.

Furthermore the device can be reset to the factory settings via object 1011h Restore Default Parameters.

Data		
MSB	LSB	
00h	00h	Producer Heartbeat Time in ms

1018h Identity Object

Object description

This object contains general information about the device.

The Vendor ID (sub-index 1h) contains a unique value allocated to each manufacturer (WIKA: 47h).

The manufacturer-specific Product code (sub-index 2h) identifies a specific device version (Product label: P#).

The manufacturer-specific Revision number (sub-index 3h) consists of a major revision number and a minor revision number. The major revision number identifies a specific CANopen behaviour. If the CANopen functionality is expanded, the major revision will be incremented. The minor revision number identifies different versions with the same CANopen behaviour.

The manufacturer-specific Serial number (sub-index 4h) identifies a specific device (Product label: S#).

Entry description

Sub-Index	00h
Name	number of entries
Access	ro
PDO Mapping	No
Data Type	UNSIGNED 8
Default Value	04h

Sub-Index	01h
Name	Vendor ID
Access	ro
PDO Mapping	No
Data Type	UNSIGNED 32
Default Value	00 00 00 47h

Sub-Index	02h
Name	Product Code
Access	ro
PDO Mapping	No
Data Type	UNSIGNED 32
Default Value	No

Sub-Index	03h
Name	Revision Number
Access	ro
PDO Mapping	No
Data Type	UNSIGNED 32
Default Value	No

Sub-Index	04h
Name	Serial Number
Access	ro
PDO Mapping	No
Data Type	UNSIGNED 32
Default Value	No

1800h Transmit PDO Communication Parameter

Object description

This object contains the communication parameters for the PDO the device is able to transmit.

Entry description

Sub-Index	00h
Name	number of entries
Access	ro
PDO Mapping	No
Data Type	UNSIGNED 8
Default Value	04h

Sub-Index	01h
Name	COB-ID used by PDO
Access	rw
PDO Mapping	No
Data Type	UNSIGNED 32
Default Value	180h + Node-ID

Sub-Index	02h
Name	Transmission Type
Access	rw
PDO Mapping	No
Data Type	UNSIGNED 8
Default Value	01h

Sub-Index	05h
Name	Event Timer
Access	rw
PDO Mapping	No
Data Type	UNSIGNED 16
Default Value	0

Changed parameters are not automatically stored, but they have to be stored via object 1010h Store Parameters.

Furthermore the device can be reset to the factory settings via object 1011h Restore Default Parameters.

(see also: 1. Process Data Object)

1A00h Transmit PDO Mapping Parameter

Object description

This object contains the mapping for the PDO the device is able to transmit.

The subindex 0h contains the number of valid entries within the mapping record. This number of entries is also the number of the application variables which shall be transmitted with the corresponding PDO.

The subindex 1h contains the information about the mapped application variable. This entry describes the PDO contents by their index, sub-index and length. All three values are hexadecimal coded. The length entry contains the length of the object in bit (20h).

Entry description

Sub-Index	00h
Name	number of entries
Access	ro
PDO Mapping	No
Data Type	UNSIGNED 8
Default Value	04h

Sub-Index	01h
Name	1 st . Mapped Application Object
Access	rw
PDO Mapping	No
Data Type	UNSIGNED 32
Default Value	2090 00 20 h

Changed parameters are not automatically stored, but they have to be stored via object 1010h Store Parameters.

Furthermore the device can be reset to the factory settings via object 1011h Restore Default Parameters.

(See also: 1. Process Data Object)

4. Object Dictionary – Manufacturer Specific Area

2010h Minimum allowed Pressure

Object description

This object defines the minimum allowed pressure. If pressure (field value) exceeds this limit an emergency message is sent.

Entry description

Access	rw
PDO Mapping	No
Data Type	UNSIGNED 16
Default Value	0000h

Changed parameters are not automatically stored, but they have to be stored via object 1010h Store Parameters.

Furthermore the device can be reset to the factory setting via object 1011h Restore Default Parameters.

If the minimum allowed pressure is set to 0, no emergency message will be send if pressure exceeds the limit.

Data		
MSB		LSB
00h	00h	Min. allowed pressure

2011h Maximum allowed Pressure

Object description

This object defines the maximum allowed pressure. If pressure (field value) exceeds this limit an emergency message is sent.

Entry description

Access	rw
PDO Mapping	No
Data Type	UNSIGNED 16
Default Value	FFFFh

Changed parameters are not automatically stored, but they have to be stored via object 1010h Store Parameters.

Furthermore the device can be reset to the factory settings via object 1011h Restore Default Parameters.

If the maximum allowed pressure is set to 0xFFFF, no emergency message will be send if pressure exceeds the limit.

Data		
MSB		LSB
00h	00h	Max. allowed pressure

2020h Min. Value Storage

Object description

This object stores minimum process value. The storage is volatile.

Entry description

Access	rw
PDO Mapping	No
Data Type	float
Default Value	No

A write access clears the actual value.

2021h Max. Value Storage

Object description

This object stores maximum process value. The storage is volatile.

Entry description

Access	rw
PDO Mapping	No
Data Type	float
Default Value	No

A write access clears the actual value.

2090h Process Value as Integer

Object description

This object contains the process value as integer.

Entry description

Access	ro
PDO Mapping	Yes
Data Type	SIGNED 32
Default Value	No

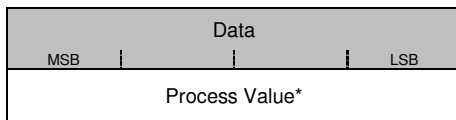

see also:
6132h Decimal Digits

2100h User Device Name

Object description

This object allows the user to program a user specific entry.

Entry description

Access	rw
PDO Mapping	No
Data Type	UNSIGNED 32
Default Value	00 00 00 00h

2201h Last Calibration Date Year

Object description

This object contains the year of the last calibration date (YY)

Entry description

Access	rw
PDO Mapping	No
Data Type	UNSIGNED 8
Default Value	No
Data Range	0 ... 99

2202h Last Calibration Date Month

Object description

This object contains the Month of the last calibration date (MM)

Entry description

Access	rw
PDO Mapping	No
Data Type	UNSIGNED 8
Default Value	No
Data Range	1 - 12

2203h Last Calibration Date Day

Object description

This object contains the day of the last calibration date (DD)

Entry description

Access	rw
PDO Mapping	No
Data Type	UNSIGNED 8
Default Value	No
Data Range	1 ... 31

2207h Date of Production Year

Object description

This object contains the year of the production date (YY)

Entry description

Access	ro
PDO Mapping	No
Data Type	UNSIGNED 8
Default Value	No
Data Range	0 ... 99

2208h Date of Production Month

Object description

This object contains the Month of the production date (MM)

Entry description

Access	ro
PDO Mapping	No
Data Type	UNSIGNED 8
Default Value	No
Data Range	1 - 12

2209h Date of Production Day

Object description

This object contains the day of the production date (DD)

Entry description

Access	ro
PDO Mapping	No
Data Type	UNSIGNED 8
Default Value	No
Data Range	1 ... 31

2320h Configure Node-ID

Object description

This object defines the Node-ID of the device. The user can configure the Node-ID via this object or LSS (layer setting services)

Entry description

Access	rw
PDO Mapping	No
Data Type	UNSIGNED 8
Default Value	01h
Data Range	01h ... 7Fh

The settings take effect after a reset.

Data			
MSB			LSB
00h	00h	00h	Node-ID

2321h Configure Bit Timing

Object description

This object defines the bitrate of the device. The user can configure the bitrate via this object or LSS (layer setting services)

Entry description

Access	rw
PDO Mapping	No
Data Type	UNSIGNED 8
Default Value	03h
Data Range	00h ... 07h

The settings take effect after a reset.

Data			
MSB			LSB
00h	00h	00h	Table index

CiA bit timing table:

Baudrate	Table Index
1000 kbit/s	0
800 kbit/s	1
500 kbit/s	2
250 kbit/s	3
125 kbit/s	4
100 kbit/s	5
50 kbit/s	6
20 kbit/s	7

2330h Auto-Operational

Object description

Through this object the user can set the device to enter the OPERATIONAL-Mode automatically after boot up.

Entry description

Access	rw
PDO Mapping	No
Data Type	UNSIGNED 8
Default Value	00h
Data Range	00h ... 01h

Changed parameters are not automatically stored, but they have to be stored via object 1010h Store Parameters.

Furthermore the device can be reset to the factory settings via object 1011h Restore Default Parameters.

5. Object Dictionary – Device Profile Area

(according CiA DS404 V1.2)

6110h AI Sensor Type

Object description

This object specifies the type of sensor, which is connected to the analogue input (Pressure Transducer).

Entry description

Sub-Index	00h
Name	number of entries
Access	ro
PDO Mapping	No
Data Type	UNSIGNED 8
Default Value	01h

Sub-Index	01h
Name	AI Sensor Type
Access	ro
PDO Mapping	No
Data Type	UNSIGNED 16
Default Value	90 (Pressure Transducer)

6114h AI ADC Sample Rate

Object description

This value has to be the conversion rate used by the AD converter. The value is given in multiples of microseconds.

Entry description

Sub-Index	00h
Name	number of entries
Access	ro
PDO Mapping	No
Data Type	UNSIGNED 8
Default Value	01h

Sub-Index	01h
Name	AI ADC Sample Rate
Access	rw
PDO Mapping	No
Data Type	UNSIGNED 32
Default Value	1000
Data Range	1000 - 255000

7100h AI Input FV

Object description

This object represents the compensated pressure value, which is not yet scaled to the physical unit of the quantity being measured.

Entry description

Sub-Index	00h
Name	number of entries
Access	ro
PDO Mapping	No
Data Type	UNSIGNED 8
Default Value	01h

Sub-Index	01h
Name	AI Input FV 1
Access	ro
PDO Mapping	No
Data Type	UNSIGNED 16
Default Value	10000 – 60000

7120h AI Input Scaling 1 FV

Object description

This object defines the field value of the first calibration point for the analogue input channel. It is scaled in physical unit of field value.

Entry description

Sub-Index	00h
Name	number of entries
Access	ro
PDO Mapping	No
Data Type	UNSIGNED 8
Default Value	01h

Sub-Index	01h
Name	AI Input Scaling 1 FV 1
Access	ro
PDO Mapping	No
Data Type	UNSIGNED 16
Default Value	10000

6121h AI Input Scaling 1 PV

Object description

This object defines the process value of the first calibration point for the analogue input channel. It is scaled in physical unit of process value.

Entry description

Sub-Index	00h
Name	number of entries
Access	ro
PDO Mapping	No
Data Type	UNSIGNED 8
Default Value	01h

Sub-Index	01h
Name	AI Input Scaling 1 PV 1
Access	rw
PDO Mapping	No
Data Type	float
Default Value	No

Changed parameters are not automatically stored, but they have to be stored via object 1010h Store Parameters.

Furthermore the device can be reset to the factory settings via object 1011h Restore Default Parameters.

7122h AI Input Scaling 2 FV

Object description

This object defines the field value of the second calibration point for the analogue input channel. It is scaled in physical unit of field value.

Entry description

Sub-Index	00h
Name	number of entries
Access	ro
PDO Mapping	No
Data Type	UNSIGNED 8
Default Value	01h

Sub-Index	01h
Name	AI Input Scaling 2 FV 1
Access	rw
PDO Mapping	No
Data Type	UNSIGNED 16
Default Value	60000

6123h AI Input Scaling 2 PV

Object description

This object defines the process value of the second calibration point for the analogue input channel. It is scaled in physical unit of process value.

Entry description

Sub-Index	00h
Name	number of entries
Access	ro
PDO Mapping	No
Data Type	UNSIGNED 8
Default Value	01h

Sub-Index	01h
Name	AI Input Scaling 2 PV 1
Access	rw
PDO Mapping	No
Data Type	float
Default Value	No

Changed parameters are not automatically stored, but they have to be stored via object 1010h Store Parameters.

Furthermore the device can be reset to the factory settings via object 1011h Restore Default Parameters.

6124h AI Input Offset

Object description

This object defines the additional offset value for the analogue input channel. It is scaled in physical unit of process value.

Entry description

Sub-Index	00h
Name	number of entries
Access	ro
PDO Mapping	No
Data Type	UNSIGNED 8
Default Value	01h

Sub-Index	01h
Name	AI Input Offset 1
Access	rw
PDO Mapping	No
Data Type	float
Default Value	No

6125h AI Autozero

Object description

Writing a signature value of „zero“ to this object causes a modification of the AI Input Offset in such a way that the actual AI Input PV becomes zero. This cycle is performed for one time.

Entry description

Sub-Index	00h
Name	number of entries
Access	ro
PDO Mapping	No
Data Type	UNSIGNED 8
Default Value	01h

Sub-Index	01h
Name	AI Autozero 1
Access	wo
PDO Mapping	No
Data Type	UNSIGNED 32
Default Value	No

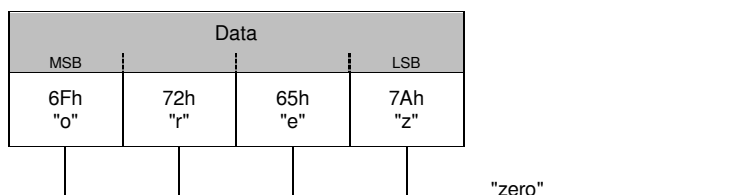

6130h AI Input PV

Object description

This object represents the result of the input scaling block and gives the measured quantity scaled in the physical unit of process values (e.g. bar, Pa,...). This object is affected by object 6132h Decimal Digits.

Entry description

Sub-Index	00h
Name	number of entries
Access	ro
PDO Mapping	No
Data Type	UNSIGNED 8
Default Value	01h

Sub-Index	01h
Name	AI Input PV 1
Access	ro
PDO Mapping	Yes
Data Type	float
Default Value	No

6131h AI Physical Unit PV

Object description

This object defines the physical unit of the process value.

Entry description

Sub-Index	00h
Name	number of entries
Access	ro
PDO Mapping	No
Data Type	UNSIGNED 8
Default Value	01h

Sub-Index	01h
Name	AI Physical Unit PV 1
Access	rw
PDO Mapping	No
Data Type	UNSIGNED 32
Default Value	00 4E 00 00h

Data			
MSB			LSB
Prefix (always 0)	SI Numerator	SI-Denominator (always 0)	reserved (always 0)

The following units are supported:

22h: Pascal	A3h: mHG
4Eh: bar	A4h: atm
A1h: at	ABh: PSI
A2h: mmH ₂ O	

The settings take effect after a reset.

Changed parameters are not automatically stored, but they have to be stored via object 1010h Store Parameters.

Furthermore the device can be reset to the factory settings via object 1011h Restore Default Parameters.

6132h AI Decimal Digits

Object description

This object describes the number of decimal digits following the decimal point.

Entry description

Sub-Index	00h
Name	number of entries
Access	ro
PDO Mapping	No
Data Type	UNSIGNED 8
Default Value	01h

Sub-Index	01h
Name	AI Decimal Digits 1
Access	rw
PDO Mapping	No
Data Type	UNSIGNED 8
Default Value	see description below
Data Range	0 – 9

The number of decimal digits is defined by a tenth of the transmitter accuracy with reference to the span.
 e.g. 0..400 bar / 0,5%: $1/10$ of 0,5% = 0,05%; 0,05% of 400 bar = 0,2 bar \Rightarrow decimal digits = 1
 e.g. -1..9 bar / 0,5% : $1/10$ of 0,5% = 0,05%; 0,05% of 10 bar = 0,005 bar \Rightarrow decimal digits = 3

The settings take effect after a reset.

Changed parameters are not automatically stored, but they have to be stored via object 1010h Store Parameters.

Furthermore the device can be reset to the factory settings via object 1011h Restore Default Parameters.

6148h AI Span Start

Object description

This value specifies the lower limit where process values are expected.

Entry description

Sub-Index	00h
Name	number of entries
Access	ro
PDO Mapping	No
Data Type	UNSIGNED 8
Default Value	01h

Sub-Index	01h
Name	AI Span Start 1
Access	ro
PDO Mapping	Yes
Data Type	float
Default Value	No

6149h AI Span End

Object description

This value specifies the upper limit where process values are expected.

Entry description

Sub-Index	00h
Name	number of entries
Access	ro
PDO Mapping	No
Data Type	UNSIGNED 8
Default Value	01h

Sub-Index	01h
Name	AI Span End 1
Access	ro
PDO Mapping	Yes
Data Type	float
Default Value	No

61A0h AI Filter Type

Object description

The object defines the type of filter to be used for calculation.
The implemented filter is manufacturer specific.

Entry description

Sub-Index	00h
Name	number of entries
Access	ro
PDO Mapping	No
Data Type	UNSIGNED 8
Default Value	01h

Sub-Index	01h
Name	AI Filter Type
Access	ro
PDO Mapping	No
Data Type	UNSIGNED 8
Default Value	64h

(see also: 7. Filter)

61A1h AI Filter Constant

Object description

Defines the number of steps used for the filter calculation.
After a change of the filter constant setting a device reset has to be performed.

Entry description

Sub-Index	00h
Name	number of entries
Access	ro
PDO Mapping	No
Data Type	UNSIGNED 8
Default Value	01h

Sub-Index	01h
Name	AI Filter Constant
Access	rw
PDO Mapping	No
Data Type	UNSIGNED 8
Default Value	8h
Data Range	1 - 128

(see also: 7. Filter)

6. Calibration

Input Scaling

- 6121h AI Input Scaling 1 PV
- 6123h AI Input Scaling 2 PV
- 7120h AI Input Scaling 1 FV
- 7122h AI Input Scaling 2 FV

The calibration is carried out via objects 6121h and 6123h. The objects 7120h and 7122h are read only.

The device is recalibrated by addressing 2 measuring points and sending the respective set value to the device. The device offsets the set value specified against the actual pressure value. The 2 measuring points ideally correspond to lower limit of range and upper limit of range which however might not be possible in each case (e.g. -1 .. x bar).

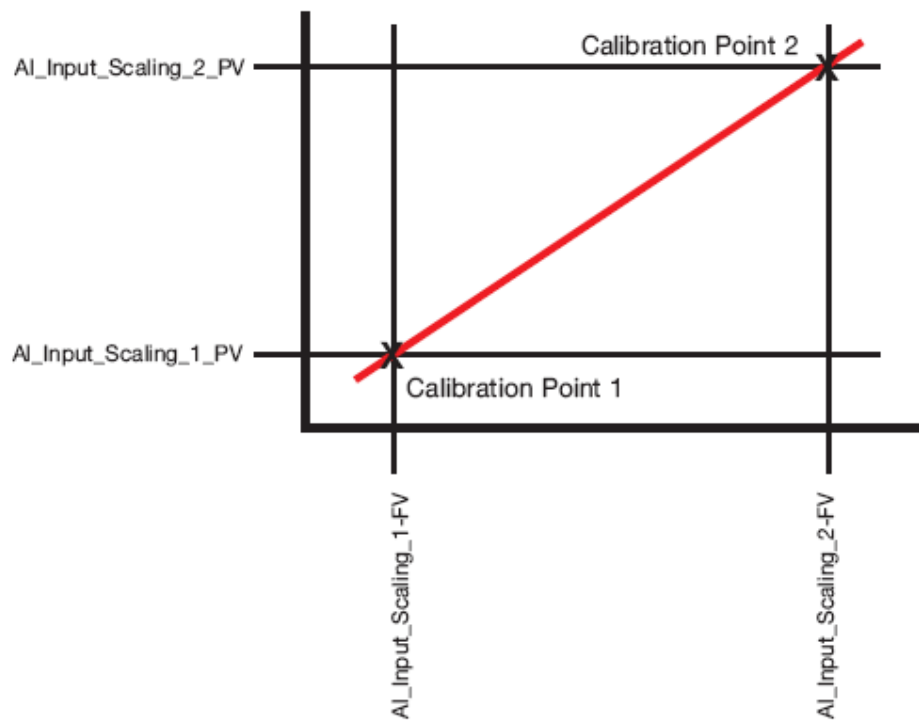

Changed parameters are not automatically stored, but they have to be stored via object 1010h Store Parameters.
Furthermore the device can be reset to the factory settings via object 1011h Restore Default Parameters.

Example 1:

Pressure Range: -1 ... 2.5 bar (=> -100,000 ... 250,000 Pa output value)

Calibration Point 1:

Pressure applied (reference value): -0.9 bar

The user writes the value that the device is supposed to indicate under the pressure currently applied to object 6121h subindex 1 (AI_Input_Scaling_1_PV), i.e. in this example -90,000 Pa (=> C2 B4 00 00 h float)

ID	DLC	Byte0	Byte1	Byte2	Byte3	Byte4	Byte5	Byte6	Byte7
600h + Node-ID	8	CS = 22h	21h Index 6121h	61h	01h Subindex	00h	00h	B4h	C2h
desired value (as float)									

The pressure transmitter confirms the successful service by:

ID	DLC	Byte0	Byte1	Byte2	Byte3	Byte4	Byte5	Byte6	Byte7
580h + Node-ID	8	CS = 60h	21h Index 6121h	61h	01h Subindex	00h	00h	00h	00h

Calibration Point 2:

Pressure applied (reference value): 2.5 bar

The user writes the value that the device is supposed to indicate under the pressure currently applied to object 6123h subindex 1 (AI_Input_Scaling_2_PV), i.e. in this example 250,000 Pa (=> 43 7A 00 00 h float)

ID	DLC	Byte0	Byte1	Byte2	Byte3	Byte4	Byte5	Byte6	Byte7
600h + Node-ID	8	CS = 22h	23h Index 6121h	61h	01h Subindex	00h	00h	7Ah	43h
desired value (as float)									

The pressure transmitter confirms the successful service by:

ID	DLC	Byte0	Byte1	Byte2	Byte3	Byte4	Byte5	Byte6	Byte7
580h + Node-ID	8	CS = 60h	23h Index 6121h	61h	01h Subindex	00h	00h	00h	00h

Input Offset

6124h AI_Input_Offset

For manual offset correction the detected offset is sent to the device, e.g. the device (pressure range 10 bar / 1,000,000 Pa) indicates 0.01 bar / 10,000 Pa at ambient pressure.

The user writes the determined offset to object 6124h subindex 1 (AI_Input_Offset_1), i.e. in this example 10,000 Pa (=> 41 20 00 00 h float)

ID	DLC	Byte0	Byte1	Byte2	Byte3	Byte4	Byte5	Byte6	Byte7
600h + Node-ID	8	CS = 22h	24h	61h	01h	00h	00h	20h	41h
			Index 6124h		Subindex	desired value (as float)			

The pressure transmitter confirms the successful service by:

ID	DLC	Byte0	Byte1	Byte2	Byte3	Byte4	Byte5	Byte6	Byte7
580h + Node-ID	8	CS = 60h	24h	61h	01h	00h	00h	00h	00h
			Index 6124h		Subindex				

Changed parameters are not automatically stored, but they have to be stored via object 1010h Store Parameters.

Furthermore the device can be reset to the factory settings via object 1011h Restore Default Parameters.

Input Autozero

6125h AI_Input_Autozero

The zero (pressure = 0) is changed to the actual pressure.

ID	DLC	Byte0	Byte1	Byte2	Byte3	Byte4	Byte5	Byte6	Byte7
600h + Node-ID	8	CS = 22h	25h	61h	01h	7Ah	65h	72h	6F
			Index 6125h		Subindex	"zero" (ASCII)			

The pressure transmitter confirms the successful service by:

ID	DLC	Byte0	Byte1	Byte2	Byte3	Byte4	Byte5	Byte6	Byte7
580h + Node-ID	8	CS = 60h	25h	61h	01h	00h	00h	00h	00h
			Index 6125h		Subindex				

Changed parameters are not automatically stored, but they have to be stored via object 1010h Store Parameters.

Furthermore the device can be reset to the factory settings via object 1011h Restore Default Parameters.

7. Filter

The D-2X-9's filter function offers many possibilities to customize the device's internal signal for the application.

Example:

Despite a superimposed sine (10 Hz-sine with 1 bar amplitude) the static pressure should be measured as precisely as possible.

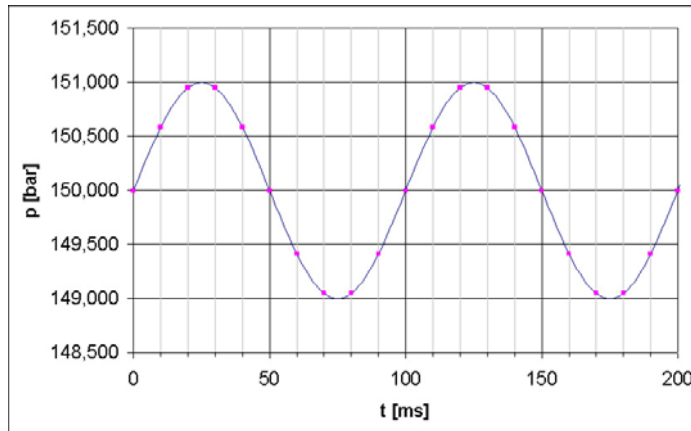

With a sample rate of 5 ms and filter value of 20, there is an averaging of the measured values of the last 100 ms.

Therefore the user receives the correct static pressure of 150 bar from the D-2X-9 output signal.

8. Emergency Object (EMCY)

Object description

Transmitter sends

ID	DLC	Byte0	Byte1	Byte2	Byte3	Byte4	Byte5	Byte6	Byte7
80h + NodeId	8	LSB Emergency Error Code	MSB Emergency Error Code	Error Register (1001h)	Manufacturer specific Error Field				

The following Emergency Error Codes are supported:

- 0000h Error Reset or No Error
- 1000h Generic Error

Error Register:

Contains the current contents of object 1001h Error Register

Manufacturer specific Error Field:

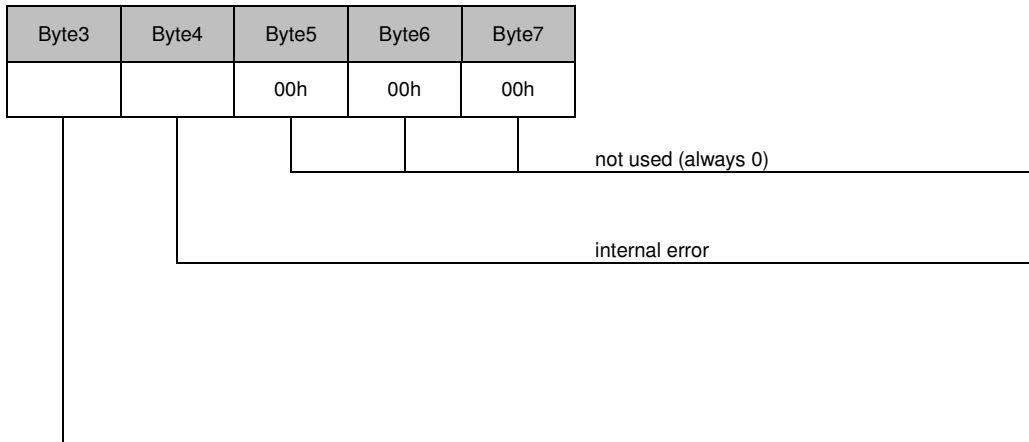

xxxx xxx1 : Error while EEPROM write
 xxxx xx1x : not used
 xxxx x1xx : Max. allowed pressure exceeds
 xxxx 1xxx : Min. allowed pressure exceeds

9. Network Management Objects

Module Control Services

Through Module Control Services, the NMT master controls the state of the NMT slaves. The state attribute is one of the values {STOPPED, PRE-OPERATIONAL, OPERATIONAL and INITIALISING}. The Module Control Services can be performed with a certain node or with all nodes simultaneously. The NMT master controls its own NMT state machine via local services, which are implementation dependent.

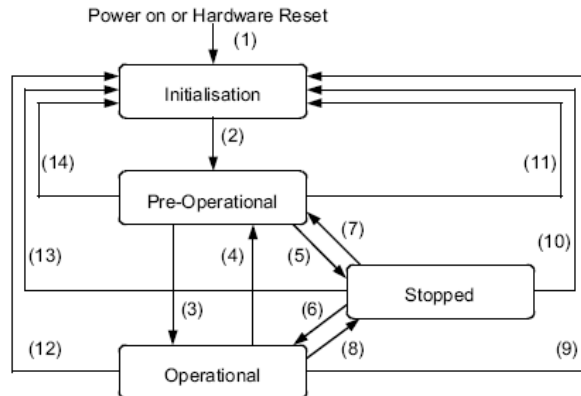

Table 31: Trigger for State Transition

(1)	At Power on the initialisation state is entered autonomously
(2)	Initialisation finished - enter PRE-OPERATIONAL automatically
(3),(6)	Start_Remote_Node indication
(4),(7)	Enter_PRE-OPERATIONAL_State indication
(5),(8)	Stop_Remote_Node indication
(9),(10),(11)	Reset_Node indication
(12),(13),(14)	Reset_Communication indication

Module Control Protocol

NMT Master request

ID	DLC	Byte0	Byte1
00h	2	CS	Node-ID (0 = all slaves)

CS: NMT command specifier

NMT services are unconfirmed.

Start Remote Node

Through this service the NMT Master sets the state of the selected NMT Slaves to "OPERATIONAL".
CS = 01h

Stop Remote Node

Through this service the NMT Master sets the state of the selected NMT Slaves to "STOPPED". This service is unconfirmed.
CS = 02h

Enter Pre-Operational

Through this service the NMT Master sets the state of the selected NMT Slaves to "PREOPERATIONAL". This service is unconfirmed.
CS = 80h

Reset Node

Through this service the NMT Master initiates a "RESET APPLICATION" of the selected NMT Slaves from any state. This service is unconfirmed.
CS = 81h

Reset Communication

Through this service the parameters of the communication profile area are set to their power-on values. After this the state "INITIALISATION" is finished and the device executes the write boot-up object service and enters the state PRE-OPERATIONAL.
CS = 82h

Error Control Services

Through Error control services the NMT detects failures in a CAN-based Network. Local errors in a node lead to a change of state (PREOPERATIONAL). Error Control services are achieved principally through periodically transmitting of messages by a device. There exist two possibilities to perform Error Control.

The guarding is achieved through transmitting guarding requests (Node guarding protocol) by the NMT Master. If a NMT Slave has not responded within a defined span of time (node life time) or if the NMT Slave's communication status has changed, the NMT Master informs its NMT Master Application about that event. If Life guarding (NMT slave guarded NMT master) is supported, the slave uses the guard time and lifetime factor from its Object Dictionary to determine the node life time. If the NMT Slave is not guarded within its life time, the NMT Slave informs its local Application about that event. If guard time and life time factor are 0 (default values), the NMT Slave does not guard the NMT Master. Guarding starts for the slave when the first remote-transmit-request for its guarding identifier is received. This may be during the boot-up phase or later.

The heartbeat mechanism for a device is established through cyclically transmitting a message by a heartbeat producer. One or more devices in the network are aware of this heartbeat message. If the heartbeat cycle fails for the heartbeat producer the local application on the heartbeat consumer will be informed about that event.

Heartbeat Protocol

The Heartbeat Protocol defines an Error Control Service without need for remote frames. A Heartbeat Producer transmits a Heartbeat message cyclically. One or more Heartbeat Consumer receive the indication. The relationship between producer and consumer is configurable via the object dictionary. The Heartbeat Consumer guards the reception of the Heartbeat within the Heartbeat Consumer Time. If the Heartbeat is not received within the Heartbeat Consumer Time a Heartbeat Event will be generated.

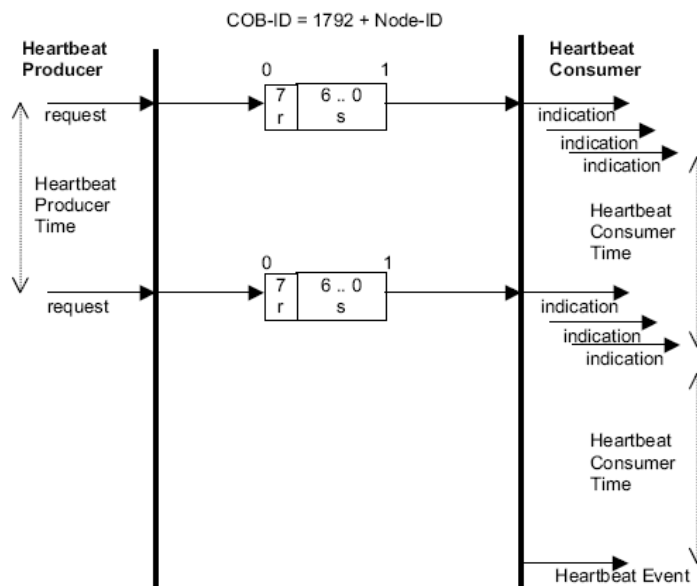

r: reserved (always 0)
s: the state of the Heartbeat producer
0: BOOTUP
4: STOPPED
5: OPERATIONAL
127: PRE-OPERATIONAL

If the Heartbeat Producer Time is configured on a device the Heartbeat Protocol begins immediately. If a device starts with a value for the Heartbeat Producer Time unequal to 0 the Heartbeat Protocol starts on the state transition from INITIALISING to PRE-OPERATIONAL. In this case the Bootup Message is regarded as first heartbeat message. It is not allowed for one device to use both error control mechanisms Guarding Protocol and Heartbeat Protocol at the same time. If the heartbeat producer time is unequal 0 the heartbeat protocol is used.

Node Guarding Protocol

This protocol is used to detect remote errors in the network. Each NMT Slave uses one remote COB for the Node Guarding Protocol. This protocol implements the provider initiated Error Control services.

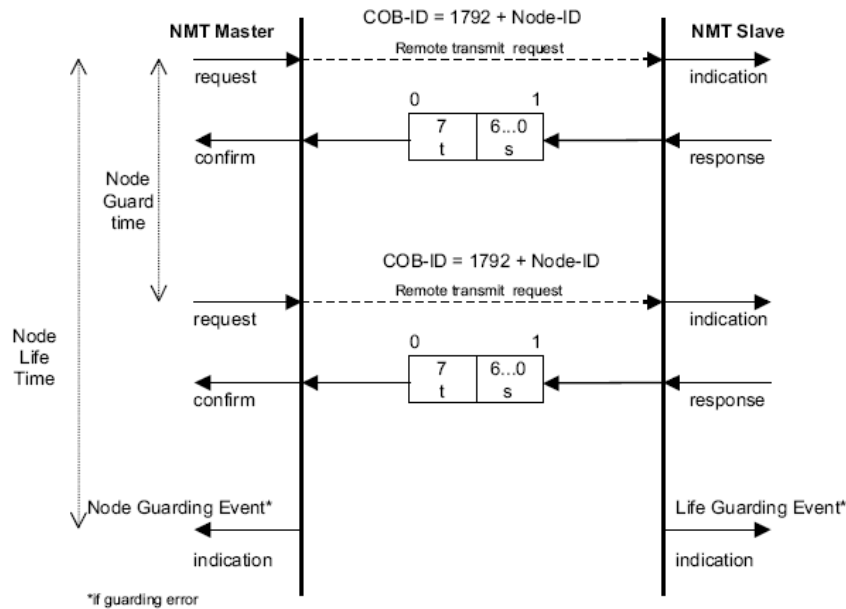

s: the state of the NMT Slave

4: STOPPED

5: OPERATIONAL

127: PRE-OPERATIONAL

t: toggle bit. The value of this bit must alternate between two consecutive responses from the NMT Slave. The value of the toggle-bit of the first response after the Guarding Protocol becomes active, is 0. The Toggle Bit in the guarding protocol is only reset to 0 when `reset_communication` is passed (no other change of state resets the toggle bit). If a response is received with the same value of the toggle-bit as in the preceding response then the new response is handled as if it was not received.

The NMT Master polls each NMT Slave at regular time intervals. This time-interval is called the guard time and may be different for each NMT Slave. The response of the NMT Slave contains the state of that NMT Slave. The node life time is given by the guard time multiplied by the life time factor. The node life time can be different for each NMT Slave. If the NMT Slave has not been polled during its life time, a remote node error is indicated through the 'Life Guarding Event' service.

A remote node error is indicated through the 'Node guarding event' service if:

- The remote transmit request is not confirmed within the node life time
- The reported NMT slave state does not match the expected state

If it has been indicated that a remote error has occurred and the errors in the guarding protocol have disappeared, it will be indicated that the remote error has been resolved through the 'Node Guarding Event' and 'Life Guarding Event' services.

For the guard time and the life time factor there are default values specified at the appropriate Object Dictionary entries.

Bootup Service

Bootup Event

Through this service, the NMT slave indicates that a local state transition occurred from the state INITIALISING to the state PRE-OPERATIONAL. The protocol uses the same identifier as the error control protocols.

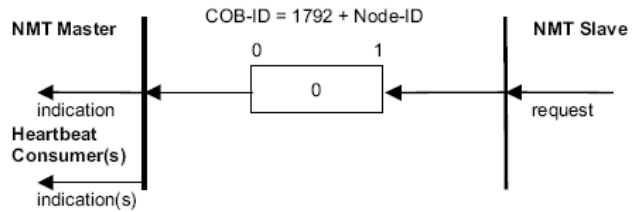

10. Layer Setting Services (LSS)

LSS offers the possibility to change the settings of

- Node-ID
- Bit timing parameters of the physical layer (baud rate)

of a CANopen Slave.

LSS Address

An LSS Slave is identified by an LSS Address. This LSS Address consists of

- vendor-id,
- product-code,
- revision-number and
- serial-number.

These parameters are identical to the Identity-Object 1018h of the object dictionary.

Switch Mode Services

The slave accepts the LSS services only in STOPPED mode (see 9. Network Management Objects).

To configure a slave via LSS the device has to be the LSS-mode CONFIGURATION.

There are two ways to do this:

- Switch Mode Global switches all LSS Slaves between configuration and operation mode (used for configuration of the bit timing).
- Switch Mode Selective switches exactly one LSS Slave between configuration and operation mode (used for configuration of the node-id)

Configuration Services

Configure Node-ID

By means of this service the LSS Master configures the NMT-address parameter of a LSS Slave.

This service allows only one LSS Slave in configuration mode. The remote result parameter confirms the success or failure of the service.

Configure Bit Timing Parameters

By means of the Configure Bit Timing Parameters service the LSS Master sets the new bit timing on a LSS Slave.

By means of the `table_selector` the bit timing parameter table to be used is specified. In the bit timing parameter table the bit timing parameters for different baud rates are specified. With `table_selector` value '0' the standard CiA bit timing parameter table is referenced. The `table_index` selects the entry (baud rate) in the selected table (value '0' refers to the highest baud rate).

<i>Baud Rate (kBit)</i>	Table Index
1000	0
800	1
500	2
250	3
125	4
100 (reserved)	5
50	6
20	7
10	8

This service has to be followed by an Activate Bit Timing Parameters service to activate the configured parameters. After execution of the Configure Bit Timing Parameters service the node may not execute any remote LSS services except the services Configure Bit Timing Parameters, Activate Bit Timing Parameters and Switch Mode.

The remote result parameter confirms the success or failure of the service.

Activate Bit Timing Parameters

By means of the Activate Bit Timing Parameters service the LSS Master activates the bit timing as defined by the Configure Bit Timing Parameters service.

The `switch_delay` parameter specifies the length of two delay periods of equal length, which are necessary to avoid operating the bus with differing bit timing parameters. Each node performs the actual switch of the bit timing parameters 'switch_delay' milliseconds after the reception of the command. After performing the switch, a node does not transmit any messages before the second time 'switch_delay' has passed.

LSS Protocol Descriptions

A protocol description specifies the sequence of COB's and their format that are exchanged between the LSS Master and LSS Slave(s) for a particular LSS service. Requesting Messages (from LSS Master) using COB-ID 2021. Response Messages (from LSS Slave) using COB-ID 2020.

LSS uses command specifiers to identify the commands.

SWITCH MODE PROTOCOLS

Switch Mode Global

LSS-Master sends

ID	DLC	Byte0	Byte1	Byte2	Byte3	Byte4	Byte5	Byte6	Byte7
7E5h	8	CS = 04h	mode	reserved					

cs: LSS command specifier
04 for Switch Mode Global

mode: The LSS mode to switch to:
0: switches to operation mode
1: switches to configuration mode

Switch Mode Selective

LSS-Master sends

ID	DLC	Byte0	Byte1	Byte2	Byte3	Byte4	Byte5	Byte6	Byte7
7E5h	8	CS = 40h	LSB Vendor-ID			MSB	reserved		

ID	DLC	Byte0	Byte1	Byte2	Byte3	Byte4	Byte5	Byte6	Byte7
7E5h	8	CS = 41h	LSB Product Code			MSB	reserved		

ID	DLC	Byte0	Byte1	Byte2	Byte3	Byte4	Byte5	Byte6	Byte7
7E5h	8	CS = 42h	LSB Revision Number			MSB	reserved		

ID	DLC	Byte0	Byte1	Byte2	Byte3	Byte4	Byte5	Byte6	Byte7
7E5h	8	CS = 43h	LSB Serial Number			MSB	reserved		

LSS-Slave answers

ID	DLC	Byte0	Byte1	Byte2	Byte3	Byte4	Byte5	Byte6	Byte7
7E4h	8	CS = 44h	reserved						

cs: LSS command specifiers;
40h to 44h for Switch Mode Selective

vendor-id: Vendor name part of the LSS address, with respect to index 1018h, subindex 1

product-code: Product name part of the LSS address, with respect to index 1018h, subindex 2

revision-number: Revision part of the LSS address, with respect to index 1018h, subindex 3

serial-number: Serial number part of the LSS address, with respect to index 1018h, subindex 4

CONFIGURATION PROTOCOLS

Configure Node-ID Protocol

LSS-Master sends

ID	DLC	Byte0	Byte1	Byte2	Byte3	Byte4	Byte5	Byte6	Byte7
7E5h	8	CS = 11h	Node-ID	reserved					

LSS-Slave answers

ID	DLC	Byte0	Byte1	Byte2	Byte3	Byte4	Byte5	Byte6	Byte7
7E4h	8	CS = 11h	error code	reserved					

cs: LSS command specifier
11h for Configure Node-ID

NID: The new Node-ID to configure

error_code: 0 : protocol successfully completed
1 : Node-ID out of range

Configure Bit Timing Parameters Protocol

LSS-Master sends

ID	DLC	Byte0	Byte1	Byte2	Byte3	Byte4	Byte5	Byte6	Byte7
7E5h	8	CS = 13h	Table Selector	Table Index	Reserved				

LSS-Slave answers

ID	DLC	Byte0	Byte1	Byte2	Byte3	Byte4	Byte5	Byte6	Byte7
7E4h	8	CS = 13h	error code	reserved					

cs: LSS command specifier
13h for Configure Node-ID

table_selector: selects which bit timing parameters table has to be used
0: standard CiA bit timing table
1..255: reserved

table_index: selects the entry (bit timing parameters) in the standard CiA bit timings table

error_code:
0: protocol successfully completed
1: bit timing not supported
2..255: reserved

Activate Bit Timing Parameters Protocol

LSS-Master sends

ID	DLC	Byte0	Byte1	Byte2	Byte3	Byte4	Byte5	Byte6	Byte7
7E5h	8	CS = 15h	Switch delay LSB MSB		Reserved				

cs: LSS command specifier
15h for Activate Bit Timing Parameters

switch_delay:
The duration of the two periods of time to wait until the bit timing parameters switch is done (first period) and before transmitting any CAN message with the new bit timing parameters after performing the switch (second period). The time unit of switch delay is 1 ms.

Example

Configure the node-ID of a slave:

- Set the device to stopped mode (see 9. Network Management Objects)
- Change from operation mode to configuration mode via **Switch Mode Selective** (see LSS Protocol Descriptions)
- Setting the node ID via **Configure Node-ID Protocol** (see LSS Protocol Descriptions)
- Change from configuration mode to operation mode via **Switch mode Global** (see LSS Protocol Descriptions)

Configure the bit timing parameters:

- Set the device to stopped mode (see 9. Network Management Objects)
- Change from operation mode to configuration mode via **Switch Mode Global** (see LSS Protocol Descriptions)
- Set baud rate via **Configure Bit Timing Parameters Protocol** (see LSS Protocol Descriptions)
- Activate bit timing via **Activate Bit Timing Parameters Protocol** (see LSS Protocol Descriptions)
- Change from configuration mode to operation mode via **Switch mode Global** (see LSS Protocol Descriptions)

11. References

ISO 11898 Controller area network (CAN)

CiA Draft Standard 301 Version 4.02 - CANopen Application Layer and Communication Profile

CiA Draft Standard 404 Version 1.2 - CANopen Device Profile Measuring Devices and Closed-Loop Controllers

CiA Draft Recommendation Proposal 303-1 Version 1.1.1 - CANopen Cabling and Connector Pin Assignment

CiA Draft Standard 102 Version 2.0 - CAN Physical Layer for Industrial Applications

CiA Draft Standard Proposal 305 Version 1.1.1 - CANopen Layer Setting Services and Protocol (LSS)

12. Definitions and abbreviations

CAN	Controller Area Network
CiA	CAN in Automation international users and manufacturers group e.V.
COB	Communication Object (CAN Message). A unit of transportation in a CAN network. Data must be sent across a CAN network inside a COB. A COB can contain at most 8 bytes of data.
COB-ID	COB-Identifier. Identifies a COB uniquely in a network. The identifier determines the priority of that COB in the MAC sub-layer too
CS	Command Specifier
EDS	Electronic Data Sheet
ISO	International Standardisation Organisation
DLC	Data Length Code of a CAN message
ID	Identifier
LSB	Least Significant Bit
LSS	Layer Setting Services. One of the service elements of the CAN Application Layer in the CAN Reference Model. It serves to configure parameters of each layer in the CAN Reference Model.
MAC	Medium Access Control. One of the sub-layers of the Data Link Layer in the CAN Reference Model that controls who gets access to the medium to send a message.
MSB	Most Significant Bit
NMT	Network Management. One of the service elements of the CAN Application Layer in the CAN Reference Model. It performs initialisation, configuration and error handling in a CAN network.
Node-ID	The Node-ID of the NMT Slave has to be assigned uniquely (1 .. 127).
OSI	Open Systems Interconnection
PDO	Process Data Object
RO	Read Only
RW	Read/Write
SDO	Service Data Object
SYNC	Synchronisation Object
WO	Write Only

13. History

Version 1: 10.02.2004

Version 2: 01.10.2004

- added description for Layer setting services (LSS)
- modified description for object 1800h Transmit PDO Communication Parameter

Version 3: 16.01.2006

- modified description for object 2320h Configure Node-ID
- modified description for object 2321h Configure Bit Timing
- added description for object 6110h AI Sensor Type
- added description for object 6114h AI ADC Sample Rate
- fixed description for Calibration functions (wrong data type entry in table)
- modified description for object 1005h COB-ID SYNC message
- added description for transmission type 253 (1. Process data object)
- modified description for object 6132h decimal digits
- fixed description for object 1A00h Transmit PDO Mapping Parameters
- modified protocol description for LSS Activate Bit Timing Parameters