

- The 384 Series is an Aluminum body 3-Way universal solenoid-operated pinch valve designed for use with highly aggressive or high-purity liquids in analytical and medical instrumentation, and industrial applications
- Hermetic separation of control mechanism and the fluid within the tubing prevents particulate contamination caused by friction of moving parts, assuring maximum purity of liquids
- Available in a large range of body sizes to accommodate a wide variety of tubing sizes
- Removable and rotatable electrical coils allow for easy installation and worry-free maintenance
- Bi-directional flow for exceptional versatility
- Meets all relevant CE directives, and is RoHS compliant
- Typical applications include:
 - Hemodialysis
 - Urinary Collection Systems
 - Intravenous (IV) Systems
 - Drug Dispensing

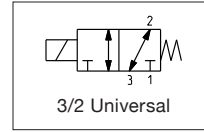

Fluids*	Temperature Range
Air, Inert Gases, Water, Oil or Liquids	0 °C to 50 °C (32 °F to 122 °F)

* Ensure that the compatibility of the fluids in contact with the materials is verified

Materials in Contact with Fluid	
Recommended Tubing	VMQ (silicone) (max. hardness: 50 Shore A) (Tubing not supplied with valve)
Other Materials	
Body	Aluminum, anodized
Pinch Mechanism	POM (Graphite-reinforced polyacetal)
Others	Stainless Steel
Guide Tube	Nickel-plated Brass

Electrical Characteristics	
Coil Insulation Class	F
Connector	Spade plug; cable Ø4-6mm (0.16-0.24in), Ø6-10mm (0.24-0.40in)
Connector Specification	4 W/8 W/6 W (DMX); DIN 43650, 9.4 mm, industry standard B; 6 W/13 W (AMX/FNX); ISO 4400/EN 175301-803, form A
Electrical Safety	IEC 335
Electrical Enclosure Protection	Coil type 01 = IP40/Coil type 02-03 = IP65
Standard Voltages ¹	12 VDC, 24 VDC
Power Consumption	4W, 6W, 8W, 9W, 13W
Response Time	< 20ms

¹ Other voltages on request

Prefix Option	Power Ratings				Ambient Temperature Ranges °C (°F)	Replacement Coil		Type ²
	Inrush VA	Holding VA	Hot/Cold W			12 VDC	24 VDC	
			W	W				
SC	-	-	4	-10 to 60 (14 to 140)	43005268	43005269	01 (DNX-4)	
			8		500701-001	500701-002		
			6		500701-003	500701-004		
			9		43005143	43005144	02 (AMX)	
			13		43005316	43005317	03 (FNX)	

² Refer to the dimensional drawings on the following page

Tube I.D. mm (inches)	Tube O.D. mm (inches)	Pinch Force daN	Pressure Differential bar (psi)			Power Coil W	Catalog Number	
			min.	max.				
				air, inert gas	liquids			
0.76 (0.030)	1.65 (0.065)	0.12	0	0.8 (11.6)	0.8 (11.6)	-	4	SCH384B004
1.02 (0.040)	2.16 (0.085)	0.18	0	0.8 (11.6)	0.8 (11.6)	-	4	SCH384B001
1.57 (0.062)	3.18 (0.125)	0.22	0	0.8 (11.6)	0.8 (11.6)	-	8	SCH384B002 ³
1.98 (0.078)	3.18 (0.125)	0.18	0	0.8 (11.6)	0.8 (11.6)	-	6	SCH384B003 ³
3.4 (0.132)	4.7 (0.183)	0.4	0	0.8 (11.6)	0.8 (11.6)	-	9	SCH384A005
4.8 (0.187)	7.9 (0.313)	0.85	0	0.8 (11.6)	0.8 (11.6)	-	13	SCH384B006
6.4 (0.250)	9.5 (0.375)	1.1	0	0.8 (11.6)	0.8 (11.6)	-	13	SCH384B007

³ Observe the minimum of time stated, see graph above

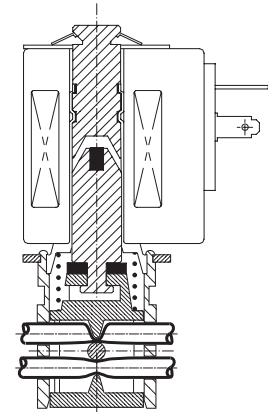

USE IN INTERMITTENT SERVICE

Minimum waiting time between each application of power

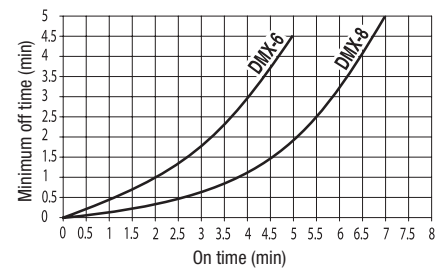

How to Order

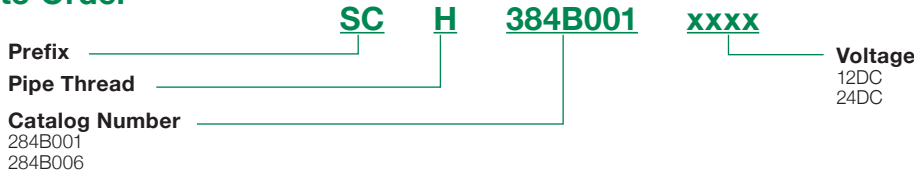

Dimensions: mm (inches)

Dimensional Drawings

Type 01

Prefix "SC" solenoid
 IEC 335/DIN 43650
 IP40



Type 01: SCH384B001/0002/003/004

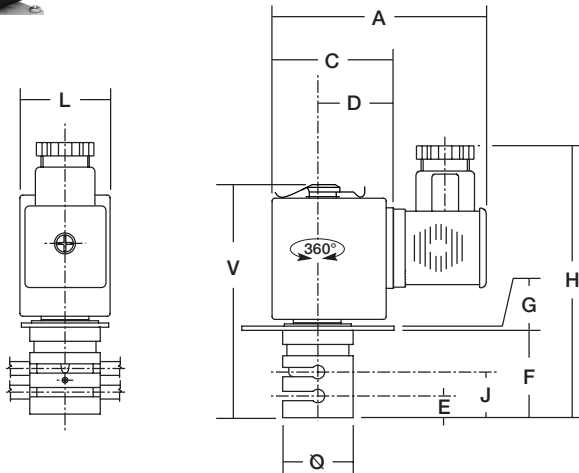

① Impulse Manual Operator

Bottom View

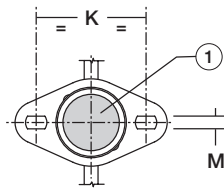

Type 02-03

Prefix "SC" solenoid
 IEC 335/ISO 4400
 IP65



Type 02: SCH384A005
Type 03: SCH384B006/B007

Tube Guiding Device

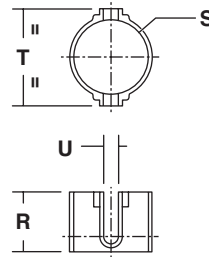

Arrangement for Wall-Fitting

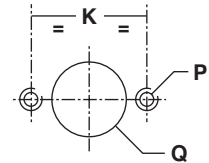

Example of Banked Assembly

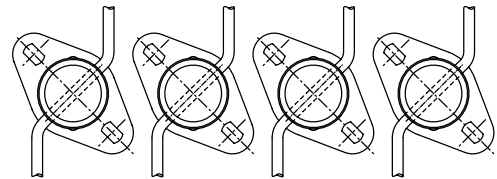

Type	Prefix Option	Catalog Number	Ø	A	C	D	E	F	G	H	K	L	M	P	Q	R	S	T	U	V	Weight ¹ kg	Tube Guiding Device	
																						Catalog Number	Weight ¹ kg
01	SC	SCH384B001/002/003/004	16 (0.63)	49.5 (1.95)	23.5 (0.92)	15 (0.59)	11 (0.24)	20 (0.79)	1 (0.04)	66 (2.60)	24 (0.43)	17 (0.67)	3.3 (0.13)	M3	16.5 (0.65)	10.7 (0.42)	16 (0.63)	24 (0.94)	2.2 (0.09)	51.2 (2.02)	0.06	C140094	0.005
02	SC	SCH384A005	25 (0.98)	78 (3.07)	43 (1.69)	27 (1.06)	17.5 (0.41)	32 (1.26)	1.5 (0.06)	99 (3.90)	39 (1.54)	32 (1.26)	3.3 (0.18)	M4	25.5 (1.00)	14 (0.55)	25 (0.98)	33 (1.30)	3.2 (0.12)	82.5 (3.25)	0.30	C140095	0.009
03	SC	SCH384B006/B007	30 (1.18)	84 (3.31)	49 (1.93)	28 (1.10)	24.5 (0.96)	43.5 (1.71)	1.5 (0.06)	99 (3.90)	45.5 (1.79)	42 (1.65)	4.5 (0.18)	M4	30.5 (1.20)	24 (0.94)	30 (1.18)	39 (1.54)	6 (0.24)	99 (3.90)	0.45	C140096	0.015

¹ Including coil(s) and connectors

Options

- Flexible tubes having to use an external guiding device for optimum support (see dimensions):
 - With an outside diameter lower than 2.2mm (0.087in) (catalog numbers **SCH384B001** to **..B004**)
 - With an outside diameter lower than 3.5mm (0.138in) (catalog number **SCH384A005**)
 - With an outside diameter lower than 6mm (0.240in) (catalog numbers **SCH384B006** and **..007**)
 - Contact us for information regarding the usage of different tubing other than those recommended
- Plug with visual indication and peak voltage suppression or with cable length of 2m (78.7in)

Installation

- The solenoid valves can be mounted in any position without affecting operation, however, for optimum performance it is recommended that they be fitted with the solenoid operator at the top
- Fixing plate built in between the body and the coil for assembly in a bank on a base plate
- Flexible tubes are not included in our supply
- Do not connect the solenoid valve to the power supply without fitting a flexible tube beforehand**