

Data Sheet

Manual Presetting Valves LENO™ MSV-O

Description

LENO™ MSV-O is a new generation of manual valves for balancing flow in heating, cooling and domestic hot water systems.

LENO™ MSV-O is a combined presetting and shut off valve with a range of unique features:

- Fixed venturi orifice.
- Removable hand wheel for easy mounting.
- Numeric presetting scale, visible from more angles.
- Easy locking of presetting.
- Built-in measuring nipples for 3mm needles.
- Open-close with Allen key in emergency.
- Open-closed colour indicator.

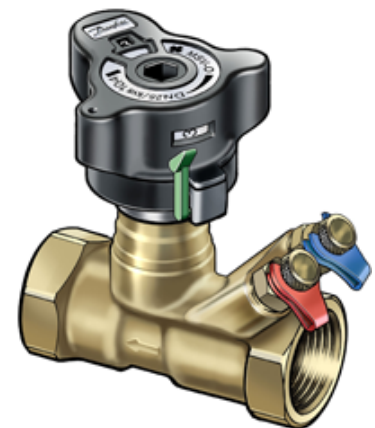

It is recommended to use LENO™ MSV-O in constant flow systems in front of boilers, flat stations or heat pumps in one-family houses for balancing, shut-off function for service and repair, flow verification, one pipe systems. The valve may be mounted in flow or return.

All dimensions are available with internal thread.

Danfoss PFM 5000/100 measuring instruments contain valve data for LENO™ MSV-O in memory.

Application

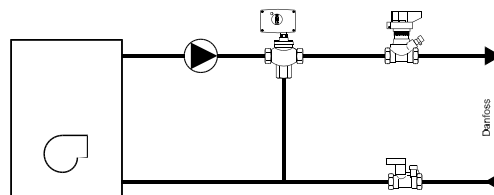

Boiler, flat station or heat pump in 1-family houses.

- For balancing.
- Shut-off function for service/repair.

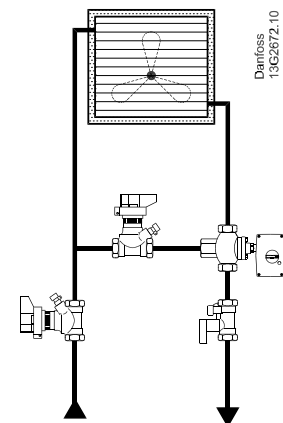

Air handling unit

- For constant flow.
- For balancing.
- Shut-off function for service/ repair.

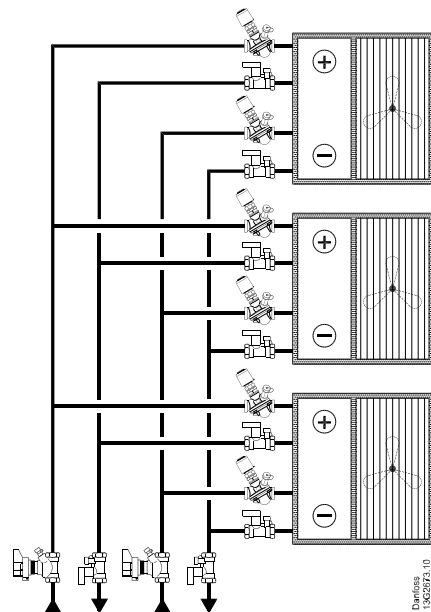

Fan coils

- For flow verification.
- Shut-off function for service/ repair.

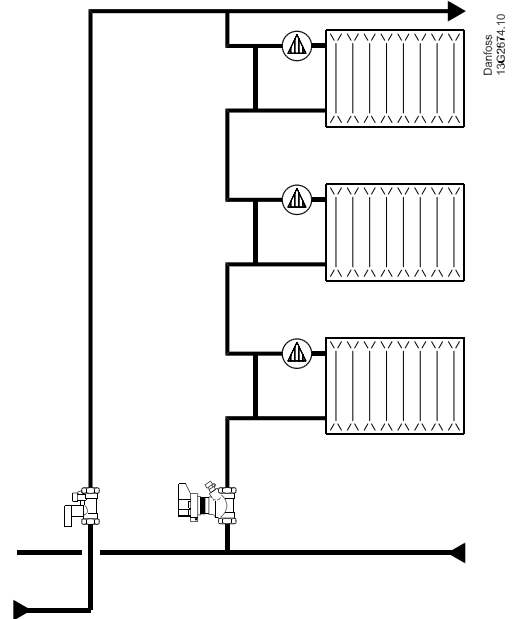

1-pipe system

- For balancing.
- Shut-off function for service/repair.

Ordering

LENO™ MSV-O valve with internal thread

Type	Material	Size	k_{vs} (m ³ /h)	Connection	Code no.
	DZR* Brass	DN 15 LF	0.63	R _p 1/2"	003Z4020
		DN 15	2.8	R _p 1/2"	003Z4021
		DN 20	5.7	R _p 3/4"	003Z4022
		DN 25	9.7	R _p 1"	003Z4023
		DN 32	16.6	R _p 1 1/4"	003Z4024
		DN 40	25.4	R _p 1 1/2"	003Z4025
		DN 50	37.9	R _p 2"	003Z4026

Accessories

Type	Code no.
Standard measuring nipples, 2 pcs.	003Z4662
Extended measuring nipples, 60 mm, 2 pcs.	003Z4657
Operating handle	003Z4652
Flow measuring instrument PFM 100	003L8260
Flow measuring instrument PFM 5000, PN10	003L8331
Flow measuring instrument PFM 5000 Multi Source, PN10	003L8333
Identification tag & strips, 10 pcs.	003Z4660

Design

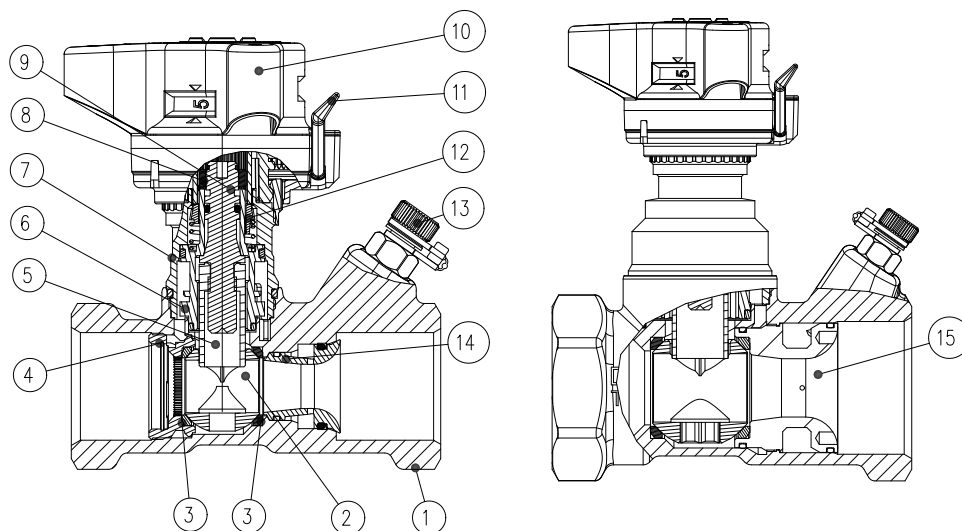

- | | | |
|------------------|-----------------|--------------------------------|
| 1. Valve house | 6. Closing bush | 11. Release lever |
| 2. Ball | 7. Valve top | 12. Rotation lock |
| 3. Ball seat | 8. Spindle head | 13. Measuring nipple |
| 4. Support screw | 9. Spindle | 14. Venturi |
| 5. Throttle | 10. Handle | 15. Support screw with venturi |

Technical Data

Materials and parts in contact with water

Valve body	DZR brass
O-rings	EPDM
Ball	Brass/chromium plated
Ball sealing	Teflon

Max. static working pressure	20 bar
Static test pressure	30 bar
Max. differential pressure across valve	2.5 bar (250 kPa)
Max. flow temperature	120 °C
Min. temperature	-20°C
Cooling liquids	Ethylene glycol / propylene glycol and HYCOOL (max. 30 %)

Fitting

Before fitting the valve the installer must ensure that the pipe system is clean and:

1. the valve can be turned 360 degrees (if threaded pipe is used).
2. the valve is fitted according to the flow direction arrow.

Removal of the handle

1. Set the handle at 0/0.
2. Release the setting lock (green).
3. Unscrew the union nut.

Calibration of the handle

Before refitting, ensure that the handle setting is 0/0.

DN	R1/R2 (mm)
15	96/58
20	99/60
25	101/63
32	124/87
40	127/90
50	131/94

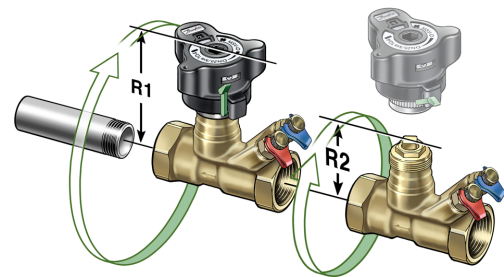

Shut-Off

In order to shut-off the valve the handle must be pressed down.

The shut-off function features a ball valve, which only requires a 90 degree turn to shut the valve completely.

An indicator window shows the actual setting:

- red = closed
- white = open

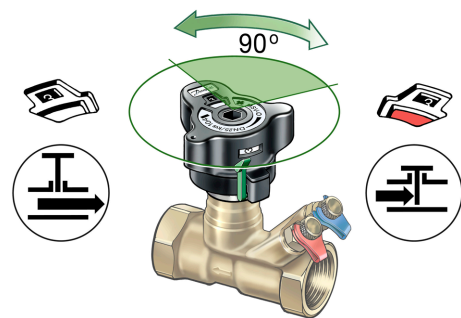

Fixed Orifice

LENO™ MSV-O has a fixed venturi orifice in the valve body with constant k_{vs} -value. This feature makes it possible to read flow on the measuring device, without typing in presetting.

This feature saves time for commissioning for each valve installed.

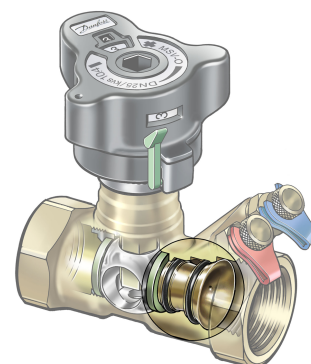

Setting and Locking

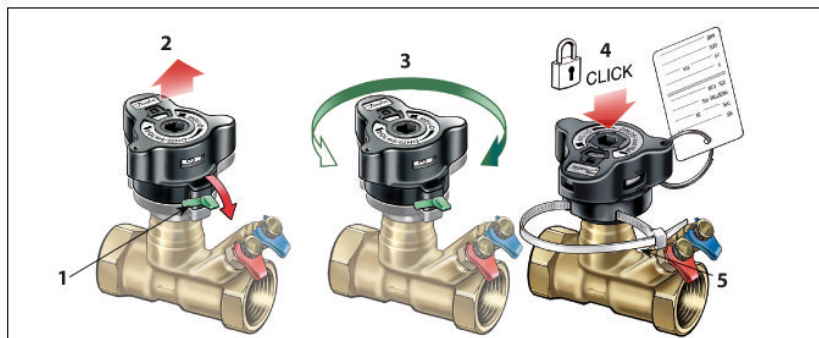

The valve has a built-in presetting feature for accurate flow ratings.

Setting the required flow is made in 5 steps:

1. Release the lock using the green lever or a 3 mm Allen key.
2. The handle pops up automatically.

3. The calculated value can now be set.
4. The setting is locked when the handle is pressed to click.
5. Seal - the setting can be protected by using a strip as shown.

Measuring

The flow through the LENO™ MSV-O valve can be measured using Danfoss PFM 5000/100 or other brands of measuring instruments. The LENO™ MSV-O valve is supplied with two measuring nipples for 3 mm needles. A twin bracket enables the user to connect both needles simultaneously.

Procedure for flow measuring:

1. Select flow measuring
2. Select valve brand
3. Select valve type and dimension
4. Connect valve and instrument
5. Calibrate static pressure
6. Measure the flow

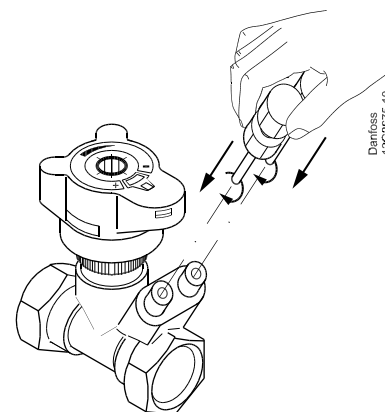

Measuring Accuracy

Maximum error in measured flow [%]

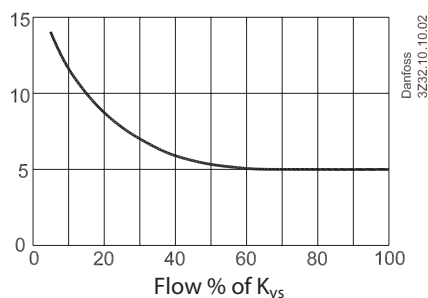

The red line indicates 25% of max. flow.

According to BS7350:1990 flow rates must be within following values:

- ± 18 % at 25 % open position
- ± 10 % at fully open position

LENO™ MSV-O is very accurate, due to the separate functions for presetting and shut-off.

K_v-Signal

K_v-signal values are used for non-Danfoss measuring instruments. Danfoss PFM 3000*/4000 have all data in memory, and the instruments are using this formula:

Δp across the measuring nipples (k_{v-sig}) and Δp across the valve (k_{v-val}) is not the same due to turbulence influence for pressure measuring.

$$\Delta P_{val} = \Delta P_{sig} \left(\frac{k_{v-sig}}{k_{v-val}} \right)^2$$

* with software 9.4 or higher

K_v-Signal Values

DN 15LF	DN 15	DN20	DN25	DN32	DN40	DN50
0.356	1.434	3.453	5.80	10.33	14.72	22.94

Sizing

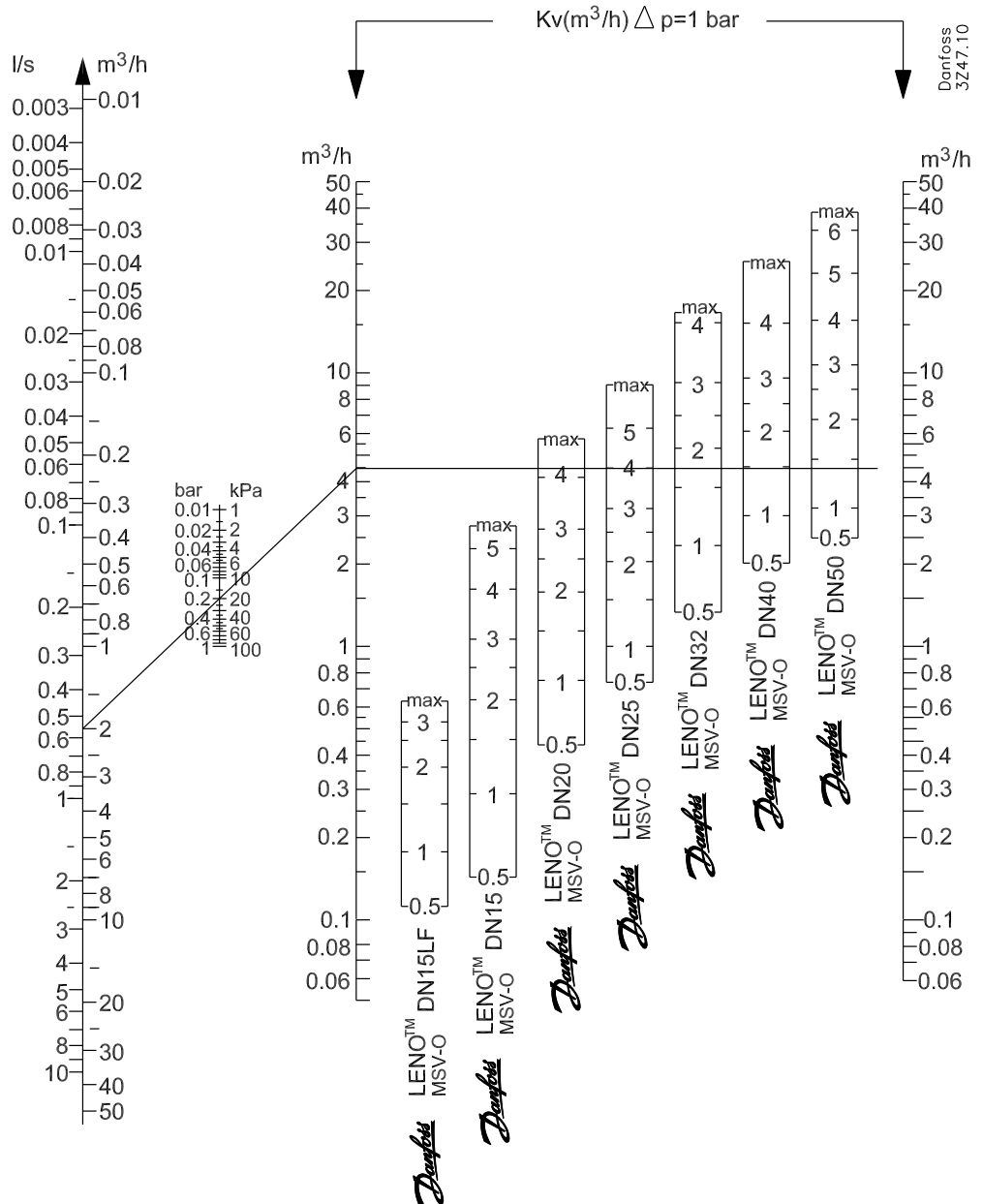

Correction Factors

Temp. °C	Correction factors, ethylene glycol / propylene glycol percentage (max. 30 %)						
	25	30	40	50	60	65	100
-40.0	1) ¹⁾	1) ¹⁾	1) ¹⁾	1) ¹⁾	0.89	0.88	1) ¹⁾
-17.8	1) ¹⁾	1) ¹⁾	0.93	0.91	0.90	0.89	0.86
4.4	0.95	0.95	0.93	0.92	0.91	0.90	0.87
26.6	0.96	0.95	0.94	0.93	0.92	0.91	0.88
48.9	0.97	0.96	0.95	0.94	0.93	0.92	0.90
71.1	0.98	0.98	0.96	0.95	0.94	0.94	0.95
93.3	1.00	0.99	0.97	0.96	0.95	0.95	0.92
115.6	2) ²⁾	2) ²⁾	2) ²⁾	2) ²⁾	2) ²⁾	2) ²⁾	0.94

¹⁾ Below freezing point

²⁾ Above boiling point

Example: Flow needed = 30 m³/h
 Flow after correction:
 30 x 0.95 = 28 m³/h

Valve Size and Presetting

Example:

Given

- Max. pipe flow Q = 2.0 m³/h
- Δp_r = 15 kPa
- Δp_a = 45 kPa
- Δp_m = 10 kPa
- Δp_i = Δp_a - Δp_v - Δp_m
- Δp_i = 45 kPa - 15 kPa - 10 kPa = 20 kPa

Correct valve size and presetting is found in flow diagramme, page 7.

Q = 2.0 m³/h and Δp_i = 20 kPa

On page 11 intersect guides and presetting is found to be 4.2 (DN 20 valve)

Setting can be also calculated from the formula:

$$k_v = \frac{Q [m^3/h]}{\sqrt{\Delta p_i [bar]}} = \frac{2.0}{\sqrt{0.20}} = 4.5 m^3/h$$

which corresponds to presetting 4.2 as shown on pages 7 and 11.

MSV-O

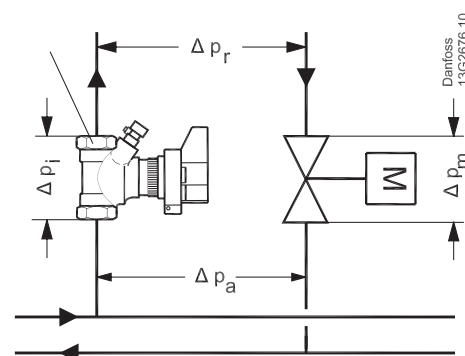

- Δp_i Pressure drop across LENO™ MSV-O valve
- Δp_m Pressure drop across valve
- Δp_r Necessary pressure for the riser
- Δp_a Available pressure for the riser

Flow Diagrammes, DN 15 LENO™ MSV-O DN 15 LF LF

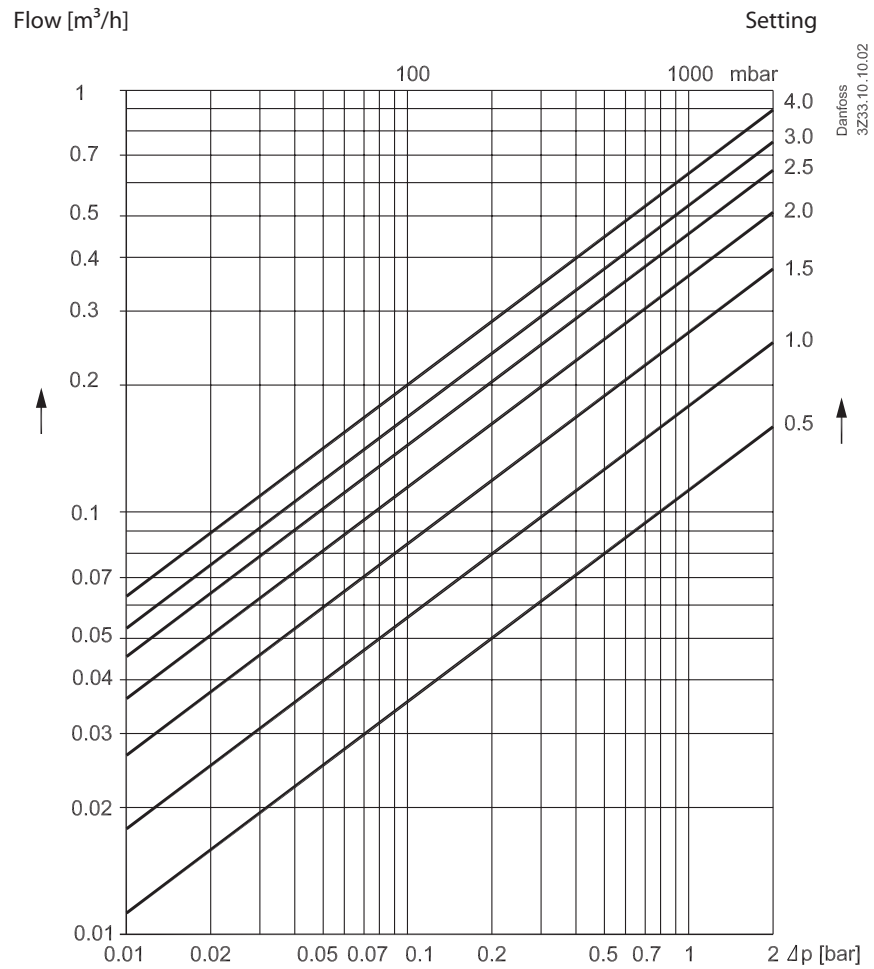

Setting	DN15LF
0.5	0.11
0.6	0.12
0.7	0.13
0.8	0.15
0.9	0.16
1.0	0.18
1.1	0.19
1.2	0.21
1.3	0.23
1.4	0.25
1.5	0.27
1.6	0.28
1.7	0.30
1.8	0.32
1.9	0.34
2.0	0.36
2.1	0.38
2.2	0.40

Setting	DN15LF
2.3	0.42
2.4	0.44
2.5	0.45
2.6	0.47
2.7	0.49
2.8	0.50
2.9	0.52
3.0	0.53
3.1	0.54
3.2	0.55
3.3	0.57
3.4	0.58
3.5	0.59
3.6	0.59
3.7	0.60
3.8	0.61
3.9	0.62
4.0	0.62
4.1	0.63

Flow characteristics

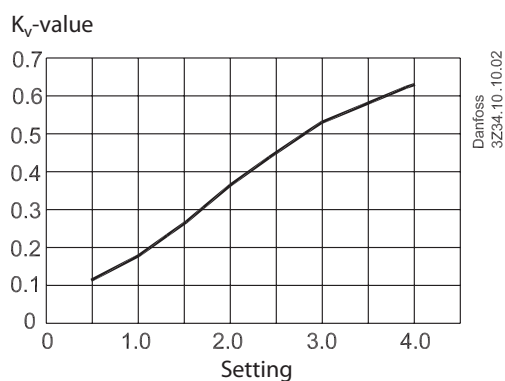

Flow Diagrammes, DN 15 LENO™ MSV-O DN 15

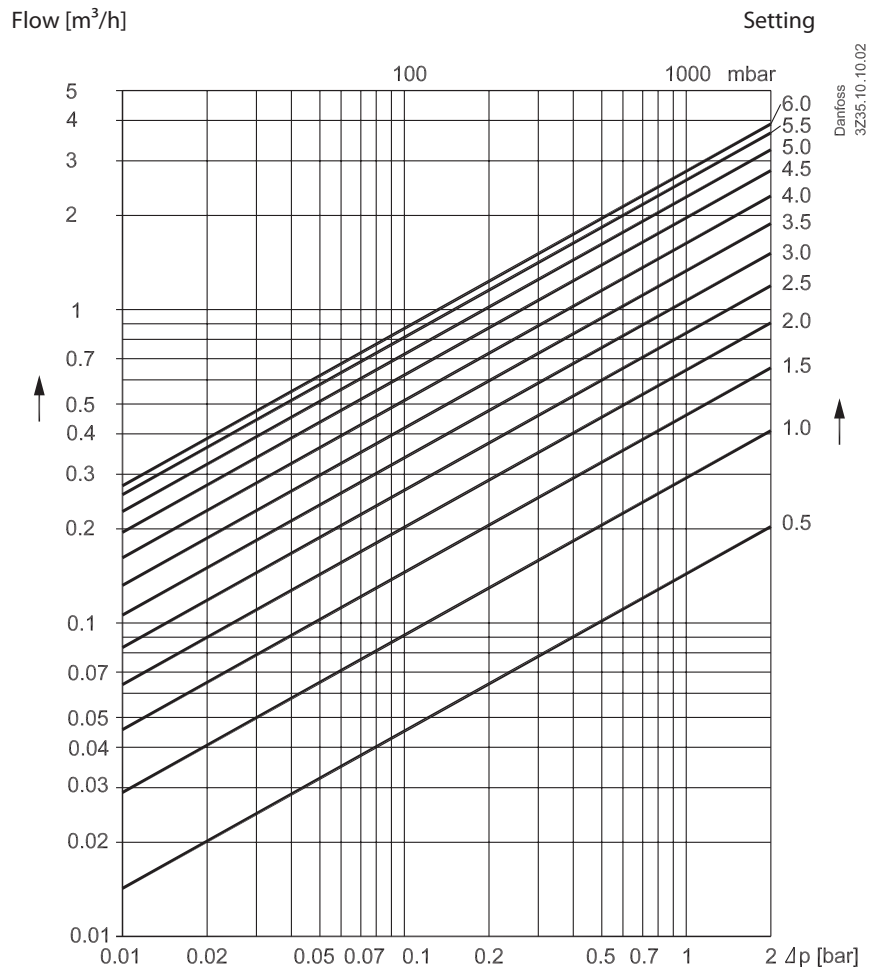

Setting	DN15
0.5	0.14
0.6	0.17
0.7	0.20
0.8	0.23
0.9	0.26
1.0	0.29
1.1	0.32
1.2	0.35
1.3	0.39
1.4	0.42
1.5	0.46
1.6	0.49
1.7	0.53
1.8	0.56
1.9	0.60
2.0	0.64
2.1	0.68
2.2	0.72
2.3	0.75
2.4	0.80
2.5	0.84

Setting	DN15
2.6	0.88
2.7	0.92
2.8	0.97
2.9	1.01
3.0	1.06
3.1	1.11
3.2	1.16
3.3	1.21

Setting	DN15
3.4	1.27
3.5	1.32
3.6	1.38
3.7	1.44
3.8	1.50
3.9	1.56
4.0	1.62
4.1	1.68
4.2	1.75
4.3	1.81
4.4	1.88
4.5	1.94
4.6	2.01
4.7	2.08
4.8	2.15
4.9	2.21
5.0	2.28
5.1	2.34
5.2	2.40
5.3	2.46
5.4	2.51
5.5	2.57
5.6	2.61
5.7	2.65
5.8	2.69
5.9	2.72
6.0	2.74
6.1	2.75
6.2	2.80

Flow characteristics

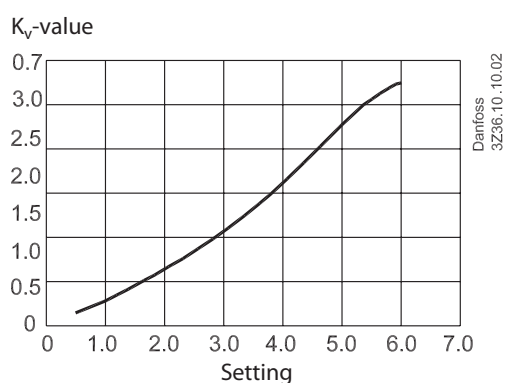

Flow Diagrammes, DN 20 LENO™ MSV-O DN 20

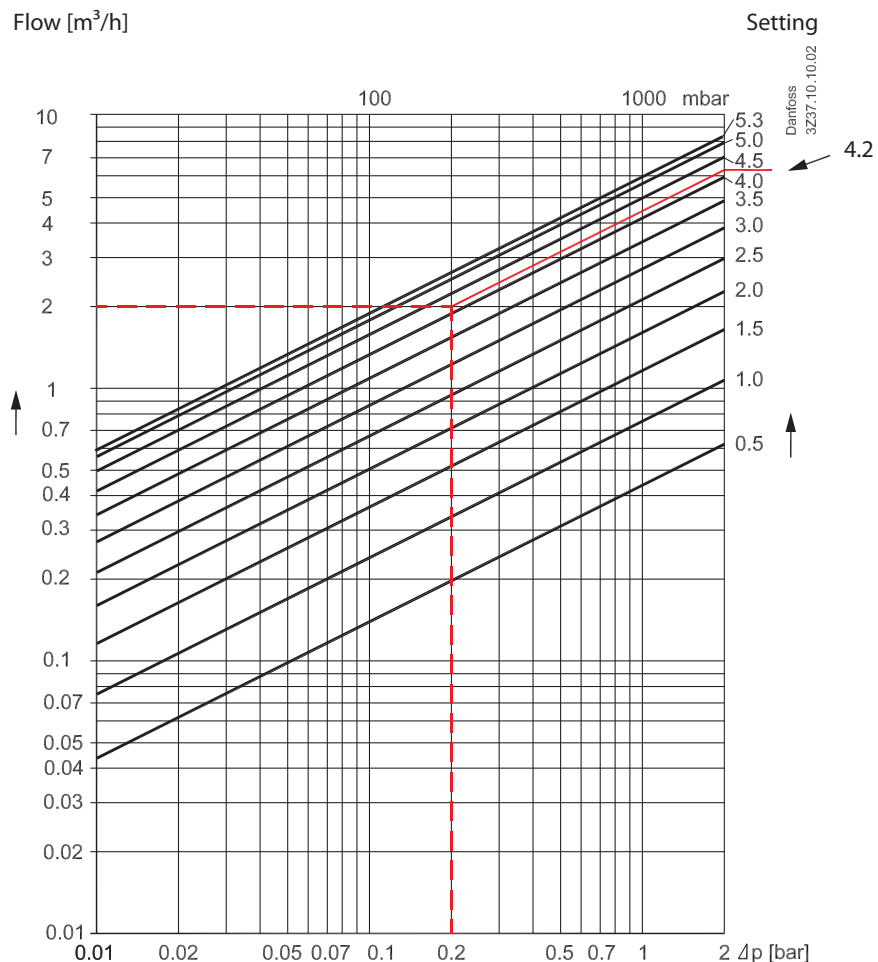

Setting	DN20
0.5	0.44
0.6	0.49
0.7	0.55
0.8	0.61
0.9	0.68
1.0	0.75
1.1	0.82
1.2	0.90
1.3	0.98
1.4	1.06
1.5	1.14
1.6	1.22
1.7	1.31
1.8	1.40
1.9	1.49
2.0	1.58
2.1	1.68
2.2	1.77
2.3	1.88
2.4	1.98
2.5	2.09
2.6	2.20

Setting	DN20
2.7	2.31
2.8	2.43

Setting	DN20
2.9	2.56
3.0	2.68
3.1	2.81
3.2	2.95
3.3	3.09
3.4	3.23
3.5	3.38
3.6	3.53
3.7	3.68
3.8	3.83
3.9	3.99
4.0	4.15
4.1	4.31
4.2	4.47
4.3	4.62
4.4	4.78
4.5	4.93
4.6	5.07
4.7	5.21
4.8	5.34
4.9	5.46
5.0	5.57
5.1	5.61
5.2	5.66
5.3	5.70

Flow characteristics

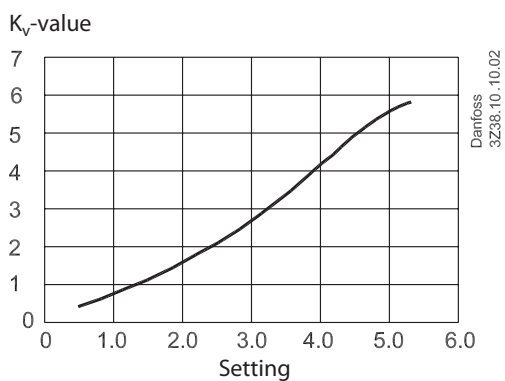

Flow Diagrammes, DN 25 LENO™ MSV-O DN 25

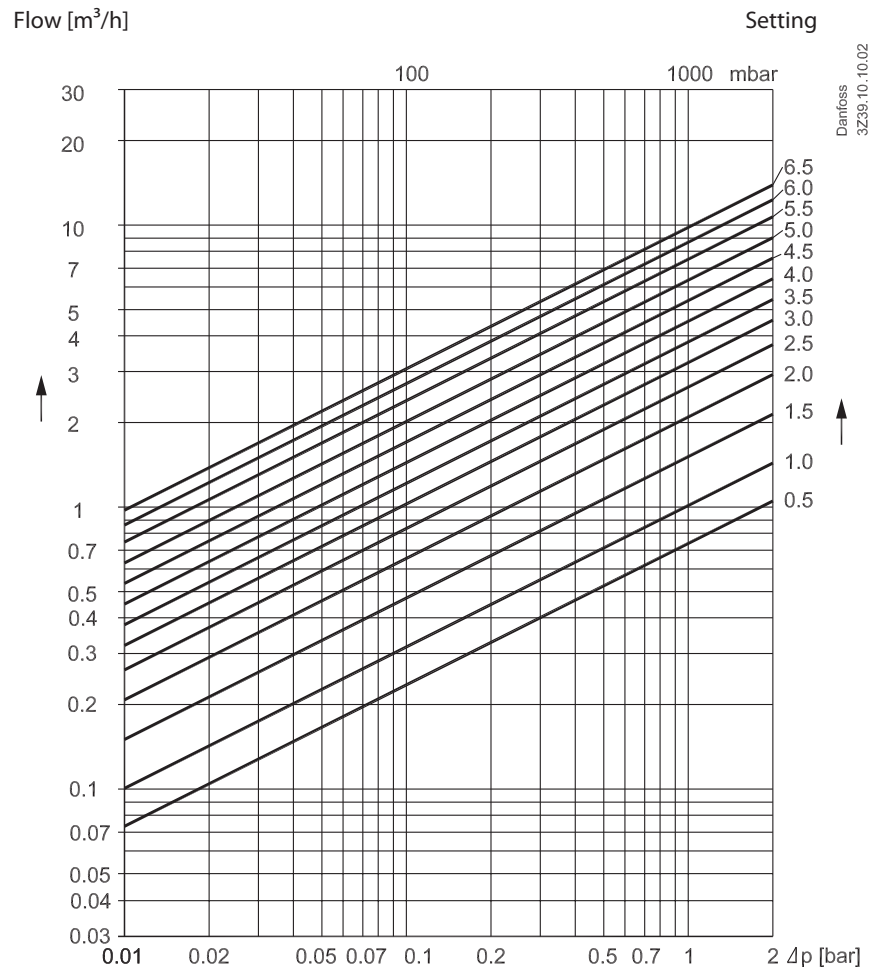

Setting	DN25
0.5	0.74
0.6	0.76
0.7	0.80
0.8	0.86
0.9	0.92
1.0	1.00
1.1	1.08
1.2	1.18
1.3	1.27
1.4	1.38
1.5	1.48
1.6	1.59
1.7	1.70
1.8	1.81
1.9	1.93
2.0	2.04
2.1	2.16
2.2	2.27
2.3	2.39
2.4	2.50
2.5	2.61

Setting	DN25
2.6	2.73
2.7	2.84
2.8	2.96
2.9	3.07
3.0	3.19
3.1	3.31
3.2	3.43
3.3	3.55
3.4	3.67

Setting	DN25
3.5	3.80
3.6	3.93
3.7	4.06
3.8	4.20
3.9	4.34
4.0	4.49
4.1	4.64
4.2	4.80
4.3	4.96
4.4	5.13
4.5	5.30
4.6	5.49
4.7	5.67
4.8	5.87
4.9	6.07
5.0	6.27
5.1	6.49
5.2	6.70
5.3	6.93
5.4	7.16
5.5	7.39
5.6	7.62
5.7	7.86
5.8	8.10
5.9	8.34
6.0	8.57
6.1	8.81
6.2	9.04
6.3	9.26
6.4	9.48
6.5	9.70

Flow characteristics

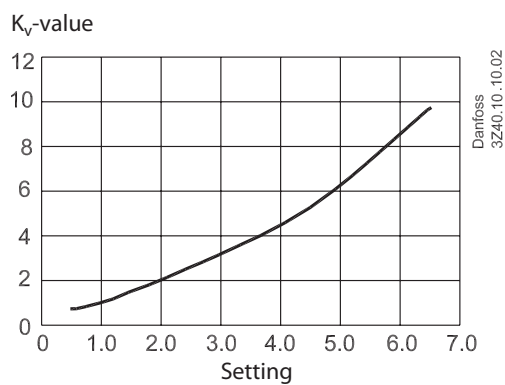

Flow Diagrammes, DN 32 LENO™ MSV-O DN 32

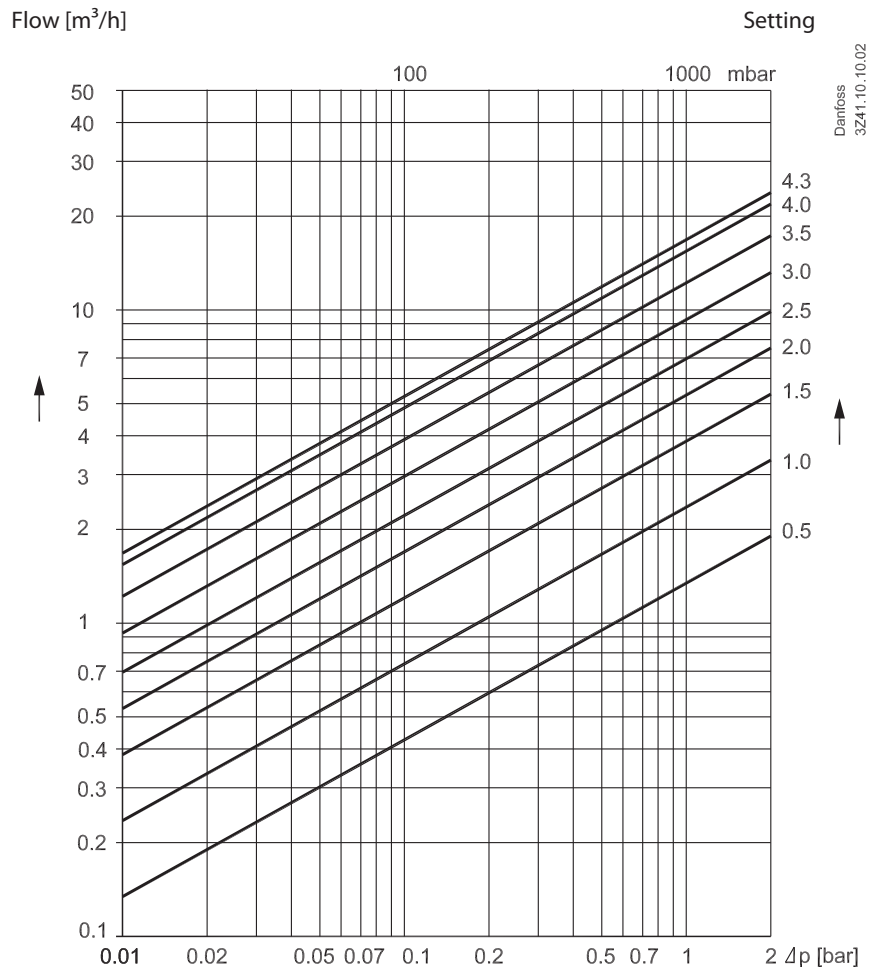

Setting	DN32
0.5	1.33
0.6	1.44
0.7	1.61
0.8	1.82
0.9	2.07
1.0	2.34
1.1	2.62
1.2	2.91
1.3	3.21
1.4	3.51
1.5	3.81
1.6	4.11
1.7	4.40
1.8	4.70
1.9	5.00
2.0	5.30
2.1	5.61
2.2	5.93
2.3	6.26

Setting	DN32
2.4	6.61
2.5	6.98
2.6	7.37
2.7	7.79
2.8	8.23
2.9	8.71
3.0	9.21
3.1	9.75
3.2	10.31
3.3	10.90
3.4	11.51
3.5	12.14
3.6	12.78
3.7	13.42
3.8	14.05
3.9	14.67
4.0	15.25
4.1	15.78
4.2	16.24
4.3	16.60

Flow characteristics

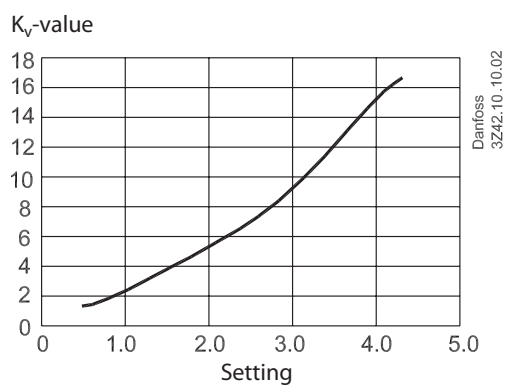

Flow Diagrammes, DN 40 LENO™ MSV-O DN 40

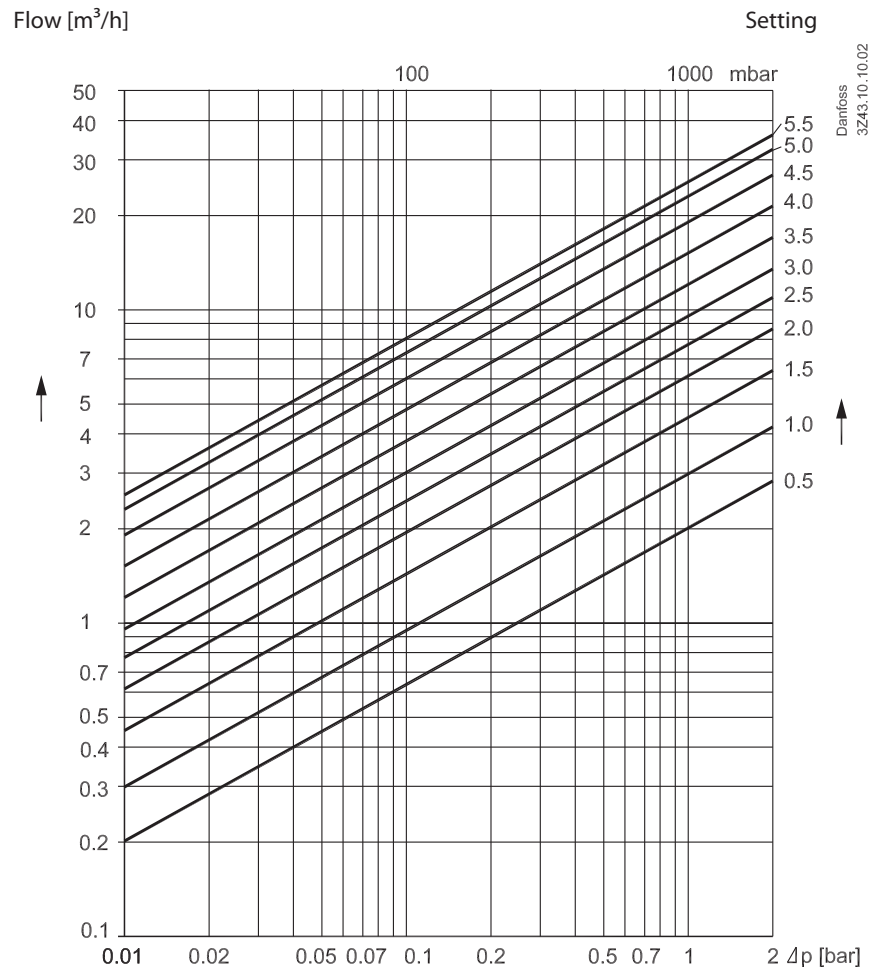

Setting	DN40
0.5	2.02
0.6	2.13
0.7	2.29
0.8	2.50
0.9	2.74
1.0	3.00
1.1	3.29
1.2	3.59
1.3	3.90
1.4	4.22
1.5	5.54
1.6	5.85
1.7	5.17
1.8	5.49
1.9	5.80
2.0	6.12
2.1	6.43
2.2	6.75
2.3	7.06
2.4	7.39
2.5	7.72

Setting	DN40
2.6	8.06
2.7	8.41
2.8	8.78
2.9	9.17

Setting	DN40
3.0	9.57
3.1	10.00
3.2	10.46
3.3	10.94
3.4	11.46
3.5	12.00
3.6	12.57
3.7	13.18
3.8	13.82
3.9	14.49
4.0	15.19
4.1	15.92
4.2	16.67
4.3	17.45
4.4	18.24
4.5	19.04
4.6	19.84
4.7	20.64
4.8	21.43
4.9	22.19
5.0	22.92
5.1	23.60
5.2	24.22
5.3	24.76
5.4	25.20
5.5	25.40

Flow characteristics

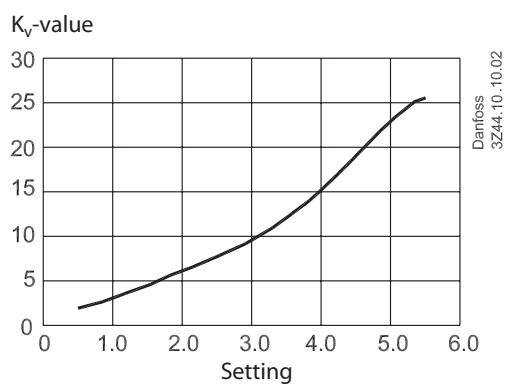

Flow Diagrammes, DN 50 LENO™ MSV-O DN 50

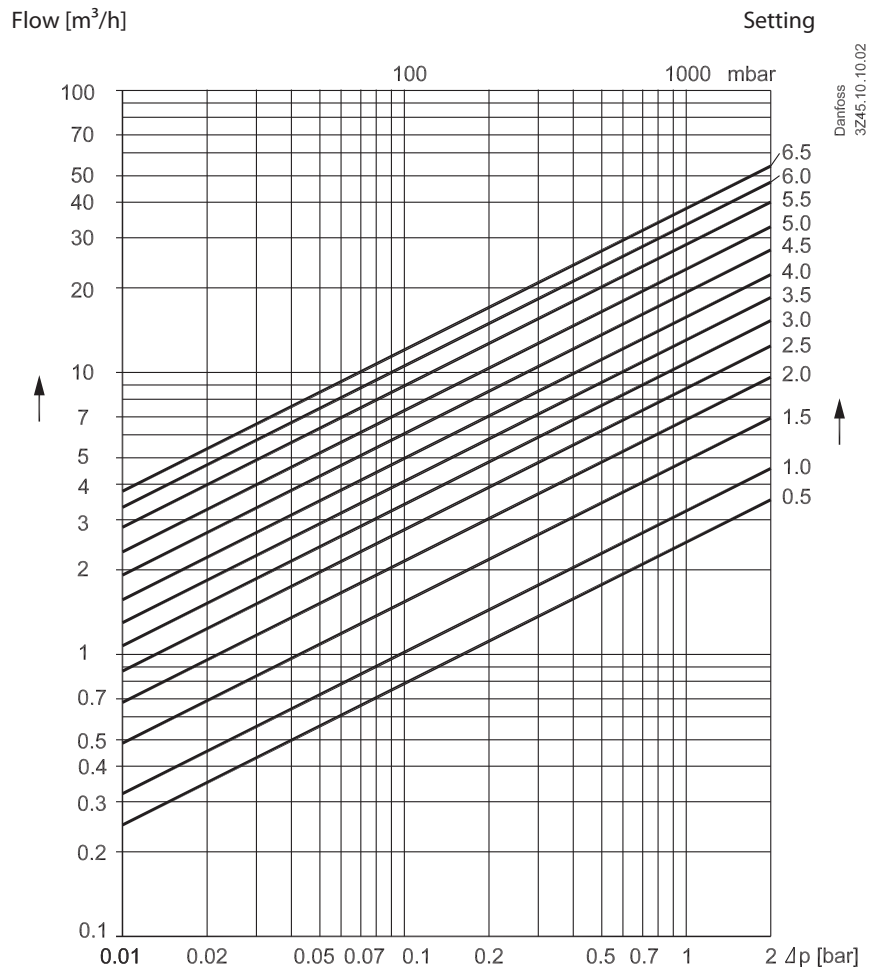

Setting	DN50
0.5	2.49
0.6	2.52
0.7	2.61
0.8	2.76
0.9	2.96
0.10	3.20
1.1	3.48
1.2	3.79
1.3	4.12
1.4	4.47
1.5	4.83
1.6	5.21
1.7	5.59
1.8	5.97
1.9	6.36
2.0	6.75
2.1	7.14
2.2	7.53
2.3	7.92
2.4	8.31
2.5	8.70

Setting	DN50
2.6	9.09
2.7	9.49
2.8	9.88
2.9	10.28
3.0	10.69
3.1	11.11
3.2	11.54
3.3	11.97
3.4	12.43

Setting	DN50
3.5	12.90
3.6	13.39
3.7	13.90
3.8	14.43
3.9	14.99
4.0	15.57
4.1	16.18
4.2	16.83
4.3	17.50
4.4	18.2
4.5	18.94
4.6	19.71
4.7	20.52
4.8	21.35
4.9	22.22
5.0	23.12
5.1	24.05
5.2	25.01
5.3	25.99
5.4	27.00
5.5	28.02
5.6	29.05
5.7	30.09
5.8	31.14
5.9	32.18
6.0	33.21
6.1	34.22
6.2	35.20
6.3	36.15
6.4	37.04
6.5	37.90

Flow characteristics

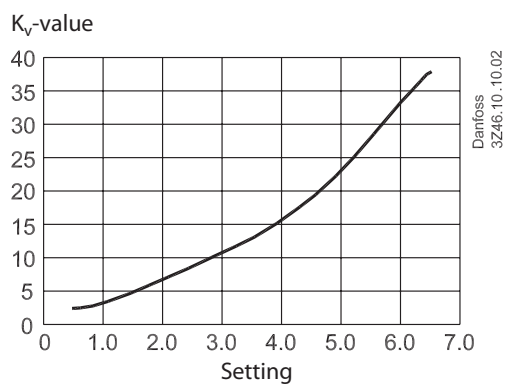

Dimensions

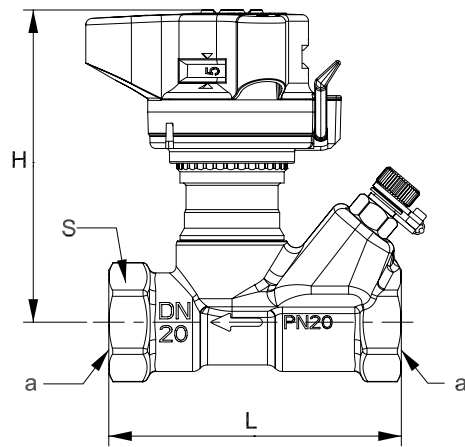

Size (DN)	ISO 228-1 a (mm)	L (mm)	H (mm)	S (mm)
15	G ½	82	92	27
20	G¾	89	95	32
25	G 1	104	98	41
32	G 1¼	122	121	50
40	G 1½	122	125	55
50	G2	151	129	67

Danfoss A/S
Heating Solutions
Haarupvaenget 11
8600 Silkeborg
Denmark
Phone: +45 7488 8000
Fax: +45 7488 8100
Email: heating.solutions@danfoss.com
www.heating.danfoss.com