

New perspectives with  
**Danfoss Saginomiya 4 - Way Reversing Valves**



Reliable season change



**STF 4-way reversing valves**

• **Wide application range**

- complete capacity range
- available for all common refrigerants (R407C, R410A, R404A, R134a, R22)
- many different connection diameters and configurations

• **High reliability**

- unique design
- instantaneous changeover at minimum pressure differential
- mechanism to prevent incomplete changeover
- minimized leakage

• **CE approved**

## 4 - WAY REVERSING VALVES SELECTION

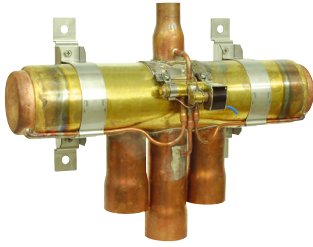

The 4 way valves are used in reversible applications such as heat pumps or reversible air conditioning units and chillers.

The 4 way valve allows an inversion of the refrigeration cycle, changing from cooling mode in summer to heating mode in winter.

The cycle inversion is initiated by a small solenoid pilot valve, which pilots the movement of a slider, which changes the direction of the refrigerant. The valve is connected to the discharge and suction pipes.

### TECHNICAL DATA AND SELECTION CRITERIA R 407 C

Model number	Discharge		Suction		Capacity / kW [condition 1] <sup>(1)</sup>		Capacity / kW [condition 2] <sup>(2)</sup>		Valve style <sup>(3)</sup>	Code number	Qty per box pcs.
	I.D. mm	O.D. inch	I.D. mm	O.D. inch	Δ p: 0,1 bar	Δ p: 0,2 bar	Δ p: 0,1 bar	Δ p: 0,2 bar			
STF-0101G	8.10	5/16"	9.70	3/8"	3.76	5.30	3.48	4.90	A	061L1206	4
										061L1188	45
STF-0104G	8.10	5/16"	9.70	3/8"	4.45	6.26	4.11	5.79	A	061L1143	45
STF-0201G	9.70	3/8"	12.95	1/2"	7.18	10.11	6.63	9.34	A	061L1207	3
										061L1144	32
STF-0204G	9.70	3/8"	16.03	5/8"	7.18	10.11	6.63	9.34	D	061L1145	32
STF-0205G	8.10	5/16"	12.95	1/2"	7.18	10.11	6.63	9.34	B	061L1146	32
STF-0208G	9.70	3/8"	16.03	5/8"	7.18	10.11	6.63	9.34	C	061L1147	32
STF-0209G	9.70	3/8"	12.95	1/2"	7.18	10.11	6.63	9.34	B	061L1148	32
STF-0214G	12.95	1/2"	16.03	5/8"	7.18	10.11	6.63	9.34	D	061L1149	32
STF-0301G	12.95	1/2"	16.15	5/8"	8.73	12.29	8.06	11.34	E	061L1208	4
										061L1194	32
STF-0306G	12.95	1/2"	19.20	3/4"	8.73	12.29	8.06	11.34	E	061L1151	32
STF-0401G	12.80	1/2"	19.15	3/4"	15.91	22.40	14.70	20.70	B	061L1209	2
										061L1152	24
STF-0404G	12.80	1/2"	19.15	3/4"	18.13	25.53	16.76	23.60	B	061L1193	24
STF-0409G	12.80	1/2"	22.40	7/8"	15.91	22.40	14.70	20.70	B	061L1154	24
STF-0413G	16.00	5/8"	22.40	7/8"	15.91	22.40	14.70	20.70	B	061L1155	24
STF-0420G	12.80	1/2"	22.40	7/8"	18.13	25.53	16.76	23.60	B	061L1156	24
STF-0712G	19.15	3/4"	22.30	7/8"	27.03	38.05	24.98	35.17	B	061L1223	1
										061L1195	6
STF-0715G	22.50	7/8"	28.70	1 1/8"	27.03	38.05	24.98	35.17	B	061L1158	6
STF-0728G	22.50	7/8"	22.30	7/8"	27.03	38.05	24.98	35.17	B	061L1160	6
STF-1511G	22.50	7/8"	28.90	1 1/8"	30.12	42.39	27.82	39.17	F	061L1224	1
STF-1513G	22.50	7/8"	35.22	1 3/8"	30.12	42.39	27.82	39.17	F	061L1217	1
STF-1514G	28.90	1 1/8"	35.22	1 3/8"	30.12	42.39	27.82	39.17	F	061L1218	1
STF-2011G	22.50	7/8"	28.90	1 1/8"	38.49	54.18	35.56	50.08	B	061L1219	1
STF-2017G	28.90	1 1/8"	35.20	1 3/8"	38.49	54.18	35.56	50.08	B	061L1225	1
STF-2501G	25.70	1"	32.05	1 1/4"	58.18	81.89	53.74	75.68	G <sup>(6)</sup>	061L1278	1
STF-2505G	28.90	1 1/8"	35.20	1 3/8"	58,18	81.89	53.74	75.68	G	061L1279	1
STF-2506G	28.90	1 1/8"	41.70	1 5/8"	58,18	81.89	53.74	75.68	G	061L1280	1
STF-3001G	32.05	1 1/4"	38.40	1 1/2"	82.13	115.61	75.87	106.83	G	061L1281	1
STF-3003G	28.50 <sup>(4)</sup>	1 1/8" <sup>(5)</sup>	41.70	1 5/8"	82.13	115.61	75.87	106.83	G	061L1282	1
STF-3006G	32.05	1 1/4"	41.70	1 5/8"	82.13	115.61	75.87	106.83	G	061L1283	1
STF-4001G	38.35	1 1/2"	45.15	1 3/4"	114.64	161.37	105.90	149.12	G	061L1284	1
STF-4002G	41.20 <sup>(4)</sup>	1 5/8" <sup>(5)</sup>	41.70	1 5/8"	114.64	161.37	105.90	149.12	G	061L1285	1
STF-4003G	35.40	1 3/8" <sup>(5)</sup>	42.40	1 5/8" <sup>(5)</sup>	114.64	161.37	105.90	149.12	G	061L1293	1
STF-5001G	38.35	1 1/2"	54.40	2 1/8"	148.86	209.54	137.52	193.64	G	061L1286	1
STF-5002G	41.20 <sup>(4)</sup>	1 5/8" <sup>(5)</sup>	54.40	2 1/8"	148.86	209.54	137.52	193.64	G	061L1287	1
STF-6001G	41.20 <sup>(4)</sup>	1 5/8" <sup>(5)</sup>	67.00	2 5/8"	236.40	333.56	192.52	275.72	G	061L1326	1

<sup>(1)</sup> condition 1: 38°C condensing / 5°C evaporating / 5°C super-heat / 0°C sub-cooling

<sup>(2)</sup> condition 2: 54,4 °C condensing / 7,2°C evaporating / 5°C super-heat / 5°C sub-cooling

<sup>(3)</sup> see valve style overview on page 7

<sup>(4)</sup> - refers to O.D.

<sup>(5)</sup> - refers to I.D.

<sup>(6)</sup> - STF-2501G does not have a bracket

Max working pressure: 45 bar

Ambient temperature : -20°C to 55°C

NOTE R407C and R410A: For discharge and suction, I.D. describes exact inner diameter of valve connections. O.D. relates to the outer diameter of connection pipe in the system.

## 4 - WAY REVERSING VALVES SELECTION

The pilot valve ensures a very reliable changeover from cooling to heating mode; the changeover happens instantaneously with a minimum pressure differential. The valve design also guarantees a minimum pressure drop and a very low risk of leakage.

The STF models offer a wide range of connection dimensions, configurations and capacity for specific applications. The standard STF models are packed as 1 pc. per box providing increased flexibility.

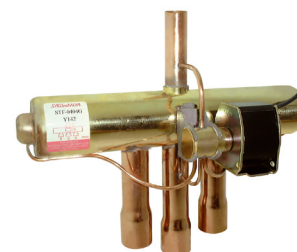

### TECHNICAL DATA AND SELECTION CRITERIA R 410 A

Model number	Discharge		Suction		Capacity / kW [condition 1] <sup>(1)</sup>		Capacity / kW [condition 2] <sup>(2)</sup>		Valve style <sup>(3)</sup>	Code number	Qty per box pcs.
	I.D. mm	O.D. inch	I.D. mm	O.D. inch	Δ p: 0,1 bar	Δ p: 0,2 bar	Δ p: 0,1 bar	Δ p: 0,2 bar			
STF-0101G	8.10	5/16"	9.70	3/8"	4.61	6.50	4.16	5.87	A	061L1206	4
					061L1188	45					
STF-0104G	8.10	5/16"	9.70	3/8"	5.46	7.69	4.91	6.93	A	061L1143	45
STF-0201G	9.70	3/8"	12.95	1/2"	8.81	12.43	7.94	11.20	A	061L1207	3
					061L1144	32					
STF-0204G	9.70	3/8"	16.03	5/8"	8.81	12.43	7.94	11.20	D	061L1145	32
STF-0205G	8.10	5/16"	12.95	1/2"	8.81	12.43	7.94	11.20	B	061L1146	32
STF-0208G	9.70	3/8"	16.03	5/8"	8.81	12.43	7.94	11.20	C	061L1147	32
STF-0209G	9.70	3/8"	12.95	1/2"	8.81	12.43	7.94	11.20	B	061L1148	32
STF-0214G	12.95	1/2"	16.03	5/8"	8.81	12.43	7.94	11.20	D	061L1149	32
STF-0301G	12.95	1/2"	16.15	5/8"	10.69	15.08	9.63	13.59	E	061L1208	4
					061L1194	32					
STF-0306G	12.95	1/2"	19.2	3/4"	10.69	15.08	9.63	13.59	E	061L1151	32
STF-0401G	12.80	1/2"	19.15	3/4"	19.50	27.51	17.58	24.80	B	061L1209	2
					061L1152	24					
STF-0404G	12.80	1/2"	19.15	3/4"	22.23	31.35	20.03	28.26	B	061L1193	24
STF-0409G	12.80	1/2"	22.40	7/8"	19.50	27.51	17.58	24.80	B	061L1154	24
STF-0413G	16.00	5/8"	22.40	7/8"	19.50	27.51	17.58	24.80	B	061L1155	24
STF-0420G	12.80	1/2"	22.40	7/8"	22.23	31.35	20.03	28.26	B	061L1156	24
STF-0712G	19.15	3/4"	22.30	7/8"	33.14	46.74	29.85	42.11	B	061L1223	1
					061L1195	6					
STF-0715G	22.50	7/8"	28.70	1 1/8"	33.14	46.74	29.85	42.11	B	061L1158	6
STF-0728G	22.50	7/8"	22.30	7/8"	33.14	46.74	29.85	42.11	B	061L1160	6
STF-1511G	22.50	7/8"	28.90	1 1/8"	36.90	52.05	33.25	46.90	F	061L1224	1
STF-1513G	22.50	7/8"	35.22	1 3/8"	36.90	52.05	33.25	46.90	F	061L1217	1
STF-1514G	28.90	1 1/8"	35.22	1 3/8"	36.90	52.05	33.25	46.90	F	061L1218	1
STF-2011G	22.50	7/8"	28.90	1 1/8"	47.19	66.55	42.52	59.98	B	061L1219	1
STF-2017G	28.90	1 1/8"	35.20	1 3/8"	47.19	66.55	42.52	59.98	B	061L1225	1
STF-2501G	25.70	1"	32.05	1 1/4"	71.30	100.56	64.24	90.62	G <sup>(6)</sup>	061L1278	1
STF-2505G	28.90	1 1/8"	35.20	1 3/8"	71.30	100.56	64.24	90.62	G	061L1279	1
STF-2506G	28.90	1 1/8"	41.70	1 5/8"	71.30	100.56	64.24	90.62	G	061L1280	1
STF-3001G	32.05	1 1/4"	38.40	1 1/2"	100.66	141.98	90.71	127.96	G	061L1281	1
STF-3003G	28.50 <sup>(4)</sup>	1 1/8" <sup>(5)</sup>	41.70	1 5/8"	100.66	141.98	90.71	127.96	G	061L1282	1
STF-3006G	32.05	1 1/4"	41.70	1 5/8"	100.66	141.98	90.71	127.96	G	061L1283	1
STF-4001G	38.35	1 1/2"	45.15	1 3/4"	140.51	198.18	126.61	178.60	G	061L1284	1
STF-4002G	41.20 <sup>(4)</sup>	1 5/8" <sup>(5)</sup>	41.70	1 5/8"	140.51	198.18	126.61	178.60	G	061L1285	1
STF-4003G	35.40	1 3/8" <sup>(5)</sup>	42.40	1 5/8" <sup>(5)</sup>	140.51	198.18	126.61	178.60	G	061L1293	1
STF-5001G	38.35	1 1/2"	54.40	2 1/8"	175.11	246.98	157.78	225.58	G	061L1286	1
STF-5002G	41.20 <sup>(4)</sup>	1 5/8" <sup>(5)</sup>	54.40	2 1/8"	175.11	246.98	157.78	225.58	G	061L1287	1
STF-6001G	41.20 <sup>(4)</sup>	1 5/8" <sup>(5)</sup>	67.00	2 5/8"	293.37	413.77	242.57	342.19	G	061L1326	1

<sup>(1)</sup> - <sup>(5)</sup> please see page 2.

### STANDARD COILS SELECTION

Code no.	Type	Cable length [mm]	Rated voltage [V AC]	Qty per box [pcs.]	Watts 50Hz (60Hz)
061L2092	STF-01AB500A1	600	24	10	6 (5)
061L2038	STF-01AB503B1	1200	24	100	6 (5)
061L2125	STF-01AJ504F1	1200	208 to 240	10	1
061L2094	STF-01AJ504F1	1200	208 to 240	10	6
061L2016	STF-01AJ504F1	1200	208 to 240	100	
061L2093	STF-01AJ506B1	600	220 to 240	10	6
061L2095	STF-01AJ512D1	2000	220 to 240	10	6
061L2074	STF-01AJ512D1	2000	220 to 240	60	

Standard coils are water-proof (IP65)

(codification of coils see page 7)

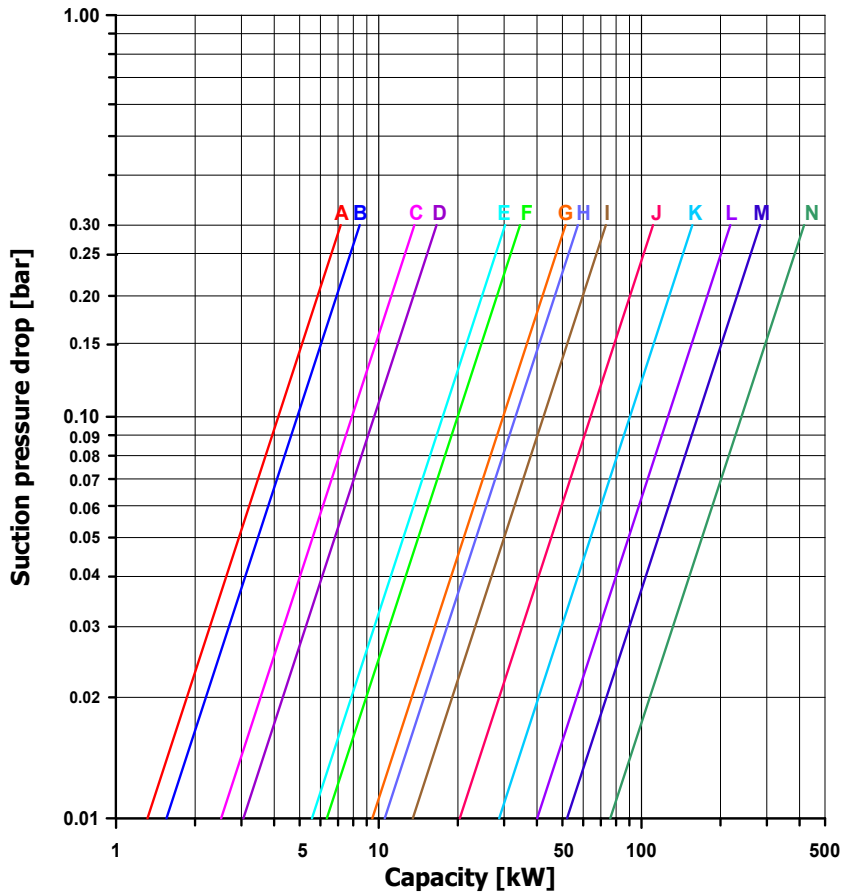

### R410A

Capacity\* for 4-way reversing valves type STF-G

- A** STF-0101G
- B** STF-0104G
- C** STF-0[201, 204, 205, 208, 209, 214]G
- D** STF-0[301, 306]G
- E** STF-0[401, 409, 413]G
- F** STF-0[404, 420]G
- G** STF-0[712, 715, 728]G
- H** STF-[1511, 1513, 1514]G
- I** STF-[2011, 2017]G
- J** STF-[2501, 2505, 2506]G
- K** STF-[3001, 3003, 3006]G
- L** STF-[4001, 4002, 4003]G
- M** STF-[5001, 5002]G
- N** STF-6001G

\* based on: Condensing Temp = 54,4 °C, Evaporating Temp = 7,2 °C  
Superheat Temp = 5 K, Supercool Temp = 5 K

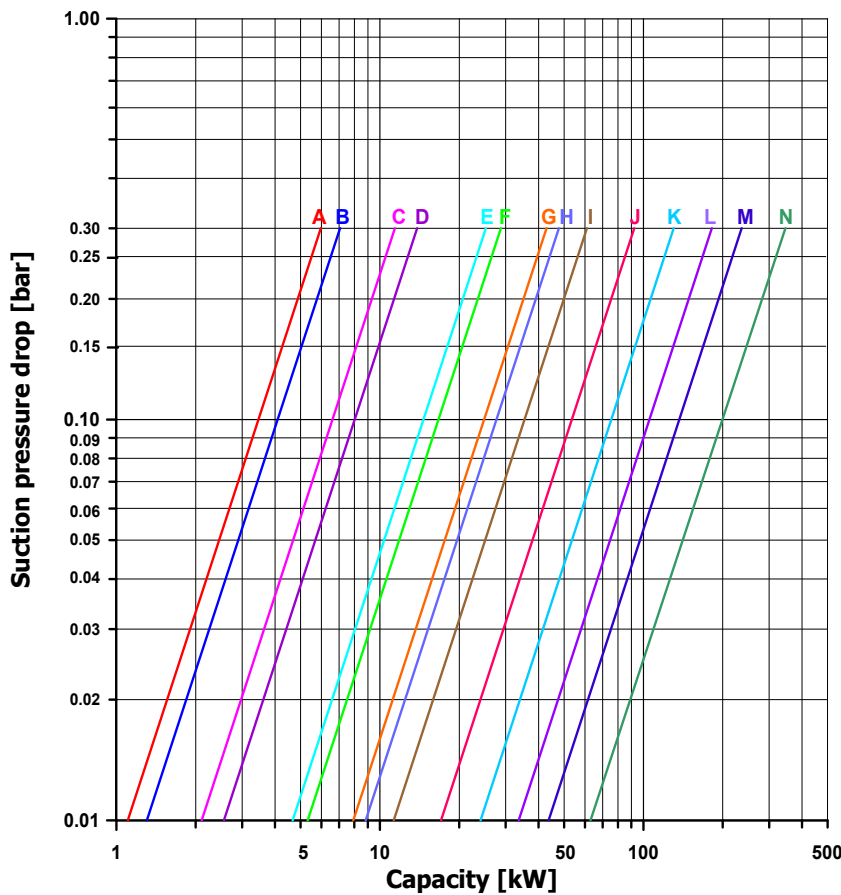

### R407C

Capacity\* for 4-way reversing valves type STF-G

- A** STF-0101G
- B** STF-0104G
- C** STF-0[201, 204, 205, 208, 209, 214]G
- D** STF-0[301, 306]G
- E** STF-0[401, 409, 413]G
- F** STF-0[404, 420]G
- G** STF-0[712, 715, 728]G
- H** STF-[1511, 1513, 1514]G
- I** STF-[2011, 2017]G
- J** STF-[2501, 2505, 2506]G
- K** STF-[3001, 3003, 3006]G
- L** STF-[4001, 4002, 4003]G
- M** STF-[5001, 5002]G
- N** STF-6001G

\* based on: Condensing Temp = 54,4 °C, Evaporating Temp = 7,2 °C  
Superheat Temp = 5 K, Supercool Temp = 5 K

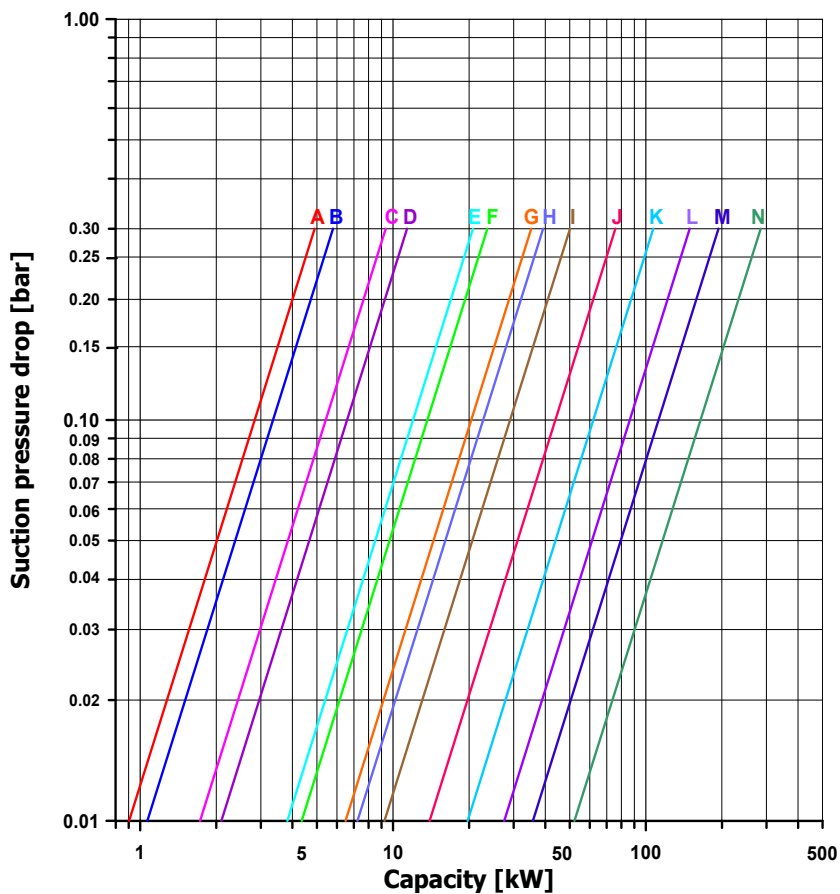

### R404A

Capacity\* for 4-way reversing valves type STF-G

- A** STF-0101G
- B** STF-0104G
- C** STF-0[201, 204, 205, 208, 209, 214]G
- D** STF-0[301, 306]G
- E** STF-0[401, 409, 413]G
- F** STF-0[404, 420]G
- G** STF-0[712, 715, 728]G
- H** STF-[1511, 1513, 1514]G
- I** STF-[2011, 2017]G
- J** STF-[2501, 2505, 2506]G
- K** STF-[3001, 3003, 3006]G
- L** STF-[4001, 4002, 4003]G
- M** STF-[5001, 5002]G
- N** STF-6001G

\* based on: Condensing Temp = 54,4 °C, Evaporating Temp = 7,2 °C  
Superheat Temp = 5 K, Supercool Temp = 5 K

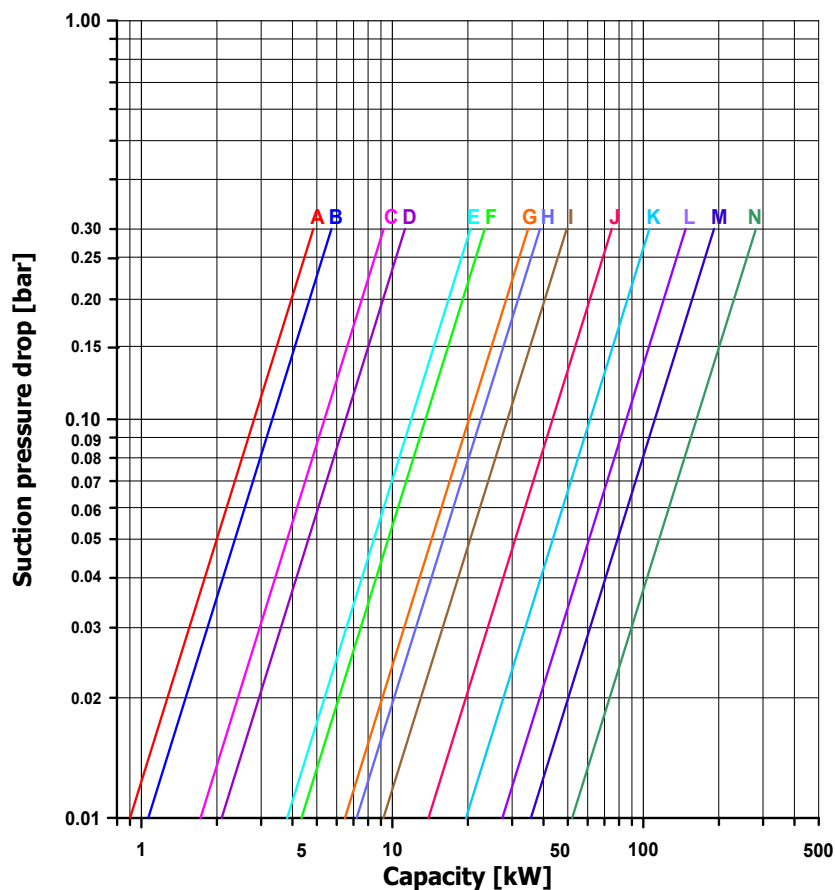

### R134a

Capacity\* for 4-way reversing valves type STF-G

- A** STF-0101G
- B** STF-0104G
- C** STF-0[201, 204, 205, 208, 209, 214]G
- D** STF-0[301, 306]G
- E** STF-0[401, 409, 413]G
- F** STF-0[404, 420]G
- G** STF-0[712, 715, 728]G
- H** STF-[1511, 1513, 1514]G
- I** STF-[2011, 2017]G
- J** STF-[2501, 2505, 2506]G
- K** STF-[3001, 3003, 3006]G
- L** STF-[4001, 4002, 4003]G
- M** STF-[5001, 5002]G
- N** STF-6001G

\* based on: Condensing Temp = 54,4 °C, Evaporating Temp = 7,2 °C  
Superheat Temp = 5 K, Supercool Temp = 5 K

CONSTRUCTION AND OPERATION IN COOLING AND HEATING CYCLE

1. discharge connection
2. connection to evaporator/ condenser
3. suction connection
4. connection to condenser/ evaporator
5. valve body
6. slider

The valve is composed of three basic components:

- pilot valve
- main valve body, including valve slider
- solenoid coil

The 4-way valve slider is shifted by changes in differential pressure in the valve which is actuated by the pilot solenoid valve. The valve slider is specially designed to prevent incomplete changeover and movement with minimum pressure differential.

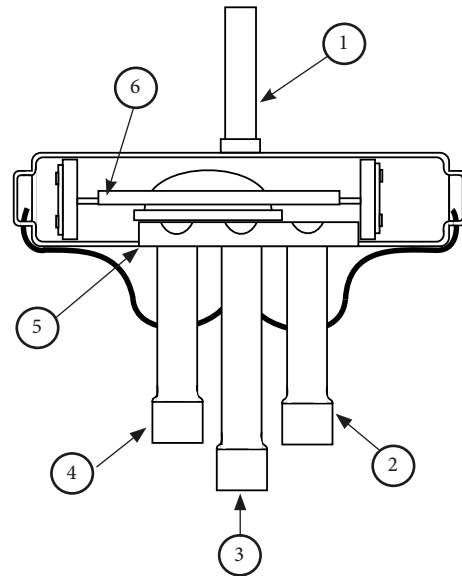

WINTER CONDITIONS

When the solenoid coil is energized (Fig 1), the pilot valve moves to the right, and the high pressure fluid enters into the piston chamber. On the other hand, the fluid is released from the piston chamber, and the piston and the slide valve portion moves to the right.

SUMMER CONDITIONS

When the solenoid coil is de-energized (Fig.2), the pilot valve moves to the left, and the high pressure fluid comes into the discharge capillary tube, and enters into the piston chamber. On the other hand, the fluid is released from the piston chamber, and the piston and the slide valve portion moves to the left.

Fig 1. HEATING CYCLE  
(Coil energized)

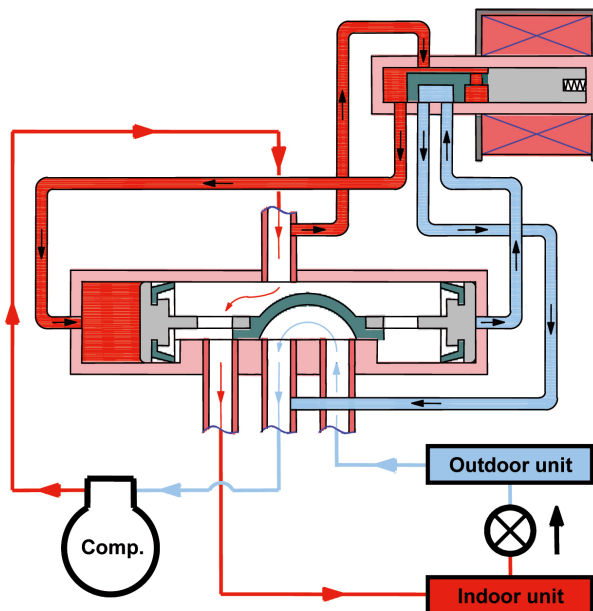
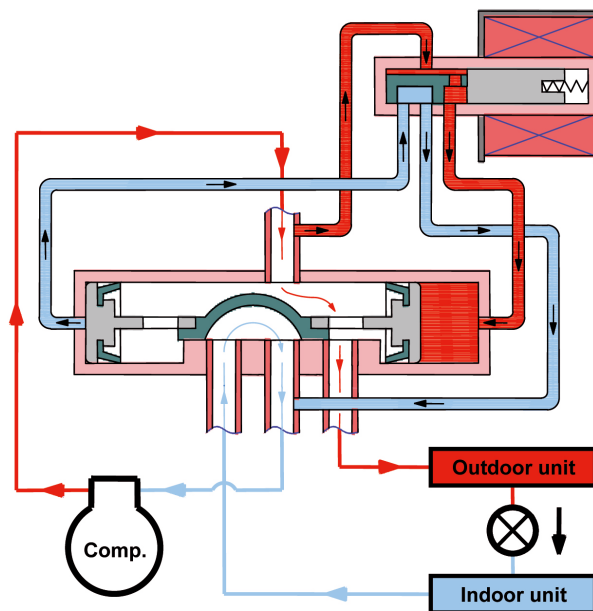
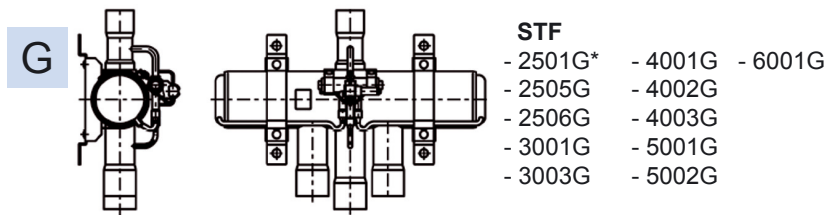
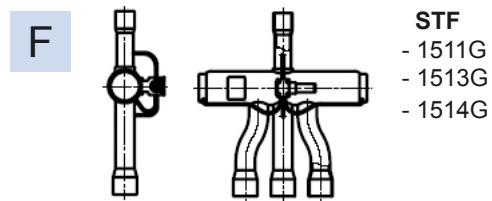
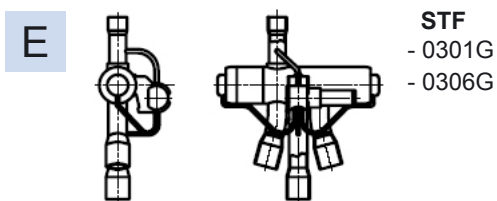
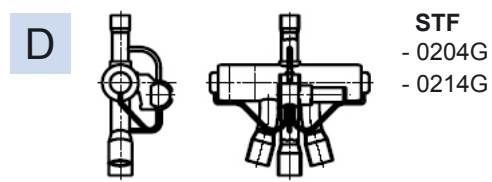
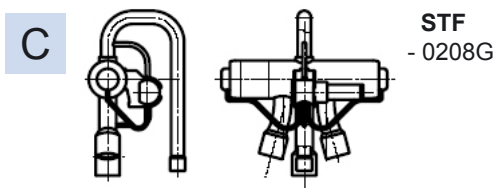
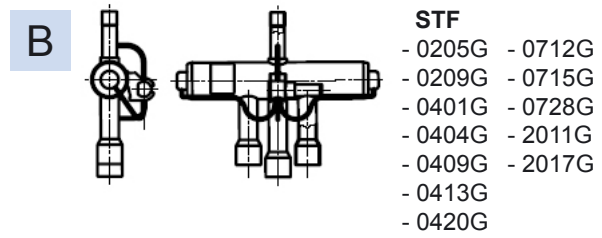
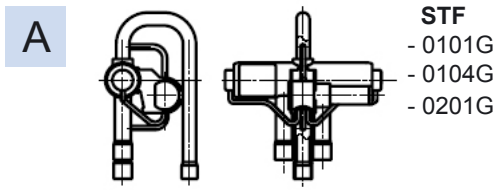

Fig. 2 COOLING CYCLE  
(Coil not energized)



# AVAILABLE VALVE AND COIL STYLES

## VALVES



\* STF-2501G does not have a bracket

## COILS CODIFICATION

Example:

STF	01A	J	504	F	1
I	II	III	IV	V	VI

- I valve type
- II coil size
- III electrical rating
- IV coil body serial number
- V lead wire / terminal style serial number
- VI screw for coil

I	<b>STF</b>	
II	01A	applicable for all valve types
	B	24V AC
	D	110V AC
	E	120V AC
III	H	220V AC
	I	230V AC
	J	220 to 240V AC
	Q	208 to 240V AC
IV	serial number relating to the coil body	
V	serial number relating to the lead wire / terminal style	
VI	1	with screw
	0	without screw

For optimum performance of 4 - way reversing valves, observe the following recommendations and guidelines:

## INSTALLATION

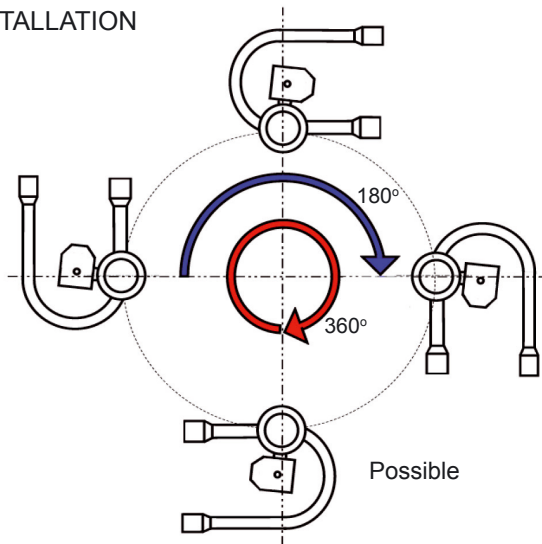

Fig. 1

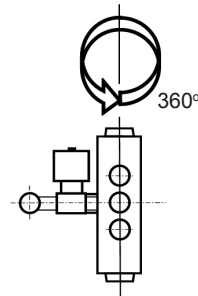

Fig. 2a

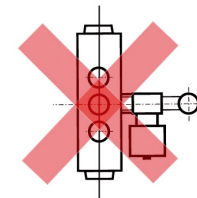

Fig. 2b

1. The following installation is possible for 4-way reversing valve:
  - a. in horizontal position, the orientation of STF series 25, 30, 40, 50 and 60 series should be in the range from 0° to 180°.  
For the remaining valve types any orientation from 0° to 360° is possible (Fig.1 ).
  - b. in vertical position, the valves can be installed in any orientation as long as the coil stem position is up (Fig. 2a).
2. Before installing, thoroughly clean the inner part of pipes to prevent dust or dirt particles from entering the valve. Use 80 to 100 mesh strainer at the valve inlet, if dust or dirt particles inside the pipes may flow into the valve.
3. Do not heat up the body to a temperature higher than 120°C when soldering the joints. Soldering must be carried out with the coil removed.
4. Do not suspend the valve by the lead wire of the solenoid coil or handle it violently.
5. Do not wrap up the solenoid coil with thermal insulation. This could cause the coil to overheat and burn out.

## FOR MOUNTING OF THE SOLENOID COIL

1. Make sure the supply voltage conforms with the voltage marked on the coil enclosure (or label).
2. When mounting the solenoid coil, the enclosure fixing bolt must be tightened firmly.
3. When wiring the solenoid coil, leave enough slack to ensure that no stresses are applied to the supply wires and coil connection.
4. When removing the solenoid coil from the body, be sure to cut out the supply power. When you keep the coil energizing itself for an unnecessary time, the coil might burn out.

Please always refer to the engineering drawings available from Danfoss technical support.