



Series "D" Pressure Controls with Mercury Switches

Specifications - Installation and Operating Instructions

Mercoïd® Series "D" Pressure Controls feature hermetically sealed mercury switches, Bourdon tube power elements, visible setpoint, adjustable deadband or fixed deadband and pressure ranges from 0-30" Hg. Vac to 800-8000 psig (345 bar).

FEATURES

- Visible calibrated dial
- On/off indication
- Adjustable, fixed deadband, or manual reset
- External switch setpoint adjustments
- Minimum deadband is obtainable at any point in the range
- Pressure Ranges of full vacuum to 8000 psig.
- UL listed, CSA approved. Many models FM approved.
- General purpose, weatherproof or explosion-proof enclosures
- Single or two stage operation

SPECIFICATIONS

Wetted Materials: Brass, 403 SS, or 316 SS.

Temperature Limit: 180°F (82°C).

Pressure Limit: Maximum pressure of the operating range.

Enclosure Rating: General purpose, weatherproof or explosion-proof.

Repeatability: ±1% of full operating range.

Switch Type: See circuit chart.

Electrical Rating: See electrical ratings chart.

Electrical Connections: Screw terminal.

Conduit Connection: General purpose: 1/2" hole for conduit hub. Weatherproof: 1/2" conduit hub. Explosion-proof: 3/4" female NPT.

Process Connection: General purpose and weatherproof: 1/4" male NPT, 1/2" male NPT on ranges 15S and 16S. Explosion-proof: 1/2" male NPT and 1/4" female NPT.

Mounting Orientation: Vertical.

Set Point Adjustment: Thumbscrew.

Weight: General Purpose: 4 lb (1.8 kg), weatherproof: 6 lb (2.7kg), explosion-proof: 8 lb (3.5 kg).

Deadband: See Ranges and Differentials Chart.

INSTALLATION

Location and Mounting

Select a location that is recommended by equipment manufacturer and reasonably free from vibration caused by reciprocating or rotating machinery. Where excessive vibration occurs, use a remote connection and mount by means of a mounting bracket or separable flange (available on order). When in doubt about excessive vibration, use a remote connection. Where pulsations, pressure surges, or water hammer are present, protect the control with a surge tank or scrubber. **Mount all controls vertically and level.**

General Purpose Controls: Install controls prefixed by the letters DA, DAF, DRF, DL, DS, DSF, firmly in a level position. Do not mount the control by twisting the case; use a wrench on the square part of the 1/4" bottom pipe connection. To level, sight across the two cover screws or check the lower end of the glass opening in the cover to see that the control is lined up horizontally. On general purpose controls provided with a flange, mount by means of the three holes in the flange.

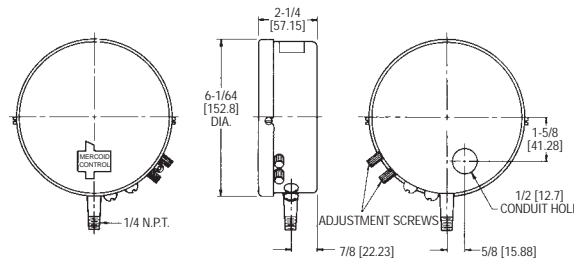

ACCESSORIES		
		
Remote Connection No. 49-62 (300 psi) No. 49-62HP (to 2500 psi)	Mounting Bracket No. 33-25	Pigtail Siphon No. 42-52 (300 psi) No. 42-58 (2,000 psi)

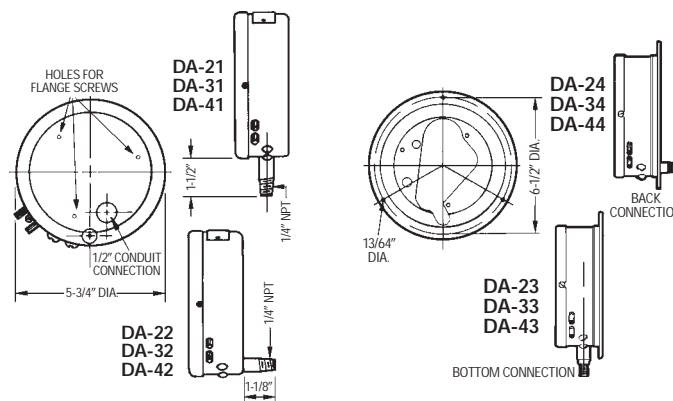

General Purpose

General Purpose with Flange for Surface Mounting

General Watertight or Weather-Resistant Types: These controls are prefixed by the letters DAW, DRW, DSW and DLW. They are supplied with flanged case, bottom connection only, for surface mounting. Again, install firmly in a **level position**. Do not mount the control by twisting the case; use a wrench on the square part of the 1/4" bottom pipe connection. Be sure pipe connection is in a vertical position. After cover is properly attached, with the name plate on bottom of the cover, sight across the lower end of the glass opening in the cover to see that the control is lined up vertically. Do not use holes in case bottom for mounting

Explosion-Proof Types: Install controls prefixed by the letters DAH, DAHF, DRH, DSH, DAE, DRE, DSE, firmly in a level position by means of mounting lugs attached to the control housing. Line up horizontally by sighting across the left and right conduit hubs.

Notes: Series D-30, D-230, D-430, D-530 (i.e., DA-31-3, etc.), when used for steam with operating ranges of 35 psi or higher, must be siphoned to prevent live steam from entering the Bourdon tube. With high pressure steam in excess of 100 psi, use a remote connection.

Series D-20, D-220, D-420, D-520 (i.e., DA-21-2, etc.), when incorporate an orifice as standard in the bottom stem to dampen out surges or pulsations.

WIRING

Wire in accordance with local electrical codes or equipment manufacturer's instructions.

For general purpose controls, use a short piece of BX between the rigid conduit and the control so that it will not be subjected to conduit expansion and contraction. Where control is directly connected into load circuit, it should be connected into hot side of line. For electrical rating, see nameplate attached to control case.

ADJUSTMENTS: How to Set Operating Point

Double Adjustment Types - Fully Automatic

Prefixed by DA, DAF, DAW, DAH, DAHF - provided with double adjustments. Adjust the upper pointer "C" to set the HIGH PRESSURE POINT for switch operation. Adjust the lower pointer "U" to set the LOW PRESSURE POINT. The difference between the HIGH and LOW pointers is the operating differential between "on-off" switch operation.

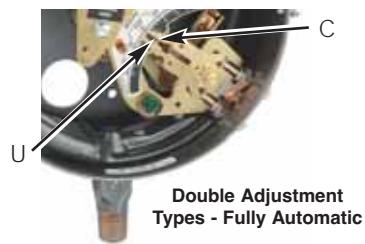

Single Adjustment Types - Fully Automatic

Prefixed by DS, DSE, DSF, DSH - equipped with a single adjustment. The single pointer on the scale sets the pressure where switch operation occurs. Differential is fixed (not adjustable). Example setting: Type DS-21-2, range 0-60 psi: circuit opens on pressure rise. If pointer is set at 40 psi, the control will operate to OPEN circuit at 40 psi and RE-CLOSE circuit at the fixed differential of 4 psi.

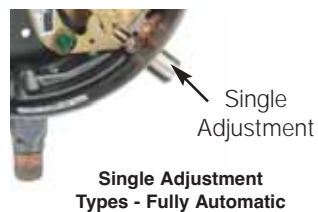

Semi-Automatic Control with Manual Reset

Prefixed by DR, DRF, DRH, DRE, DRW - with suffix -L or -U. Example: Type DR-21-2U. A single adjustment sets the operating point for automatic operation. A push-button reset must be operated manually to restore the circuit to the original position after automatic operation. Example: Type DA-21-2L. Circuit will open automatically on a pressure rise to the pressure indicated by the pointer on the scale. No matter how much the pressure drops, the circuit will not re-close until the reset button has been operated.

Suffix -L denotes control will operate automatically on an increase in pressure.

Suffix -U denotes control will operate automatically on a decrease in pressure.

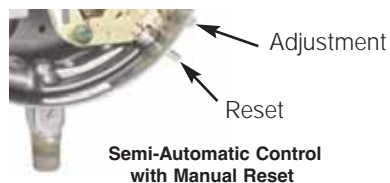

Manual Lock Type Reset Control

Operates automatically on a decrease of pressure with provision for manual reset when pressure is below set point. Prefixed by DL, DLW, DLE, DLH. A single adjustment sets the low pressure operating point of the control at any value on the scale range. The control will operate automatically at the set point only on a drop in pressure. The lock-type feature permits the circuit to be reset and locked in position when pressures are below control setting. The lock remains in effect until the pressure has risen to a value above the control setting. Lock then releases and the circuit is held in the reset position due to the pressure rise. It will remain in the reset position until it is called on to again operate automatically on a pressure drop to the selected setting.



Two-Stage Pressure Controls - Series D-400

Types DA, DAW, DAH, DAE - with suffixes 421, 423, 431, 433, etc., followed by specification numbers 4122, 4123, 4129, 4132.

This series incorporates two single pole, single throw magnetic mercury switches, actuated by the same Bourdon tube. The operating point of each switch is adjustable through an outside adjustment.

The change in pressure which opens and closes each switch at its respective setting is the switch's fixed differential. The pressure represented by the difference between the two adjustment pointers is the pressure "spread" between operation of the two switches. Upper pointer "U" indicates the operating point of the HIGH pressure circuit. Lower point "L" indicates the operating point of the low pressure circuit.

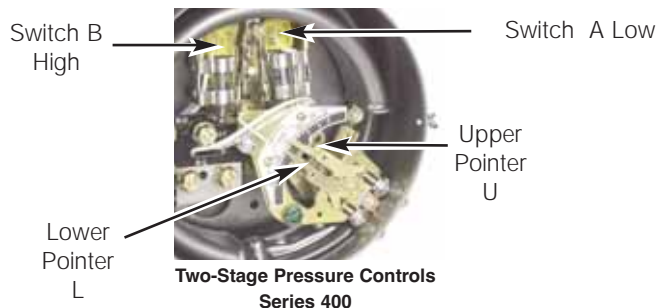

Example Setting: Type DA-421, Specification No. 4122, range 0-60 psi. With lower pointer "L" set at 25 psi and upper pointer "U" set at 50 psi, both circuits will be closed when pressure is 25 psi and lower. When pressure rises to 26 psi, mercury switch A will open its circuit. When pressure rises to 50 psi, mercury switch B will open its circuit. Both switches remain open above this setting. The fixed differential (sensitivity) of each switch for this particular range is 1 psi. Upon a drop in pressure, mercury switch "B" will close its circuit at 49 psi; mercury switch "A" will close its circuit at 25 psi.

LOCKING DEVICE

When the control has been adjusted to desired range, the locking bar may be inserted between the adjustment screws with slot passing over the hole in the lug. By placing a sealing wire between the locking bar and the hole in the lug protruding from the adjustment assembly, adjustments cannot be tampered with.

For DAF, DRF, DSF, DAW, DRW, DSW, the adjusting knob cover may be sealed in place with sealing wire through the cover bolt hole. For DAH, DSH, sealing wire may pass through locking bar and hole in hub above the adjusting knobs.

CAUTIONS

Do not exceed maximum adjustment/operating range of control. Remove control if higher pressures are required.

Do not fail to use a siphon on steam where range is 35 lbs. or more. Control movement must not be oiled.

Do not overload — note electrical rating on nameplate and be sure total current passing through switch is within specified rating.

Do not tamper with switch wires. Position of these wires is essential to proper operation. Tampering with these wires will void warranty.

**Series D Pressure Controls
Ranges and Differentials**

Controls with Mercury Switches			Adjustable Differential Double Adjustment for setting both 'on and 'off' operating points Maximum Differential - full scale. Minimum Differential listed below.		Fixed Differential Single Adjustment Adjustable operating point. Differential fixed NOT ADJUSTABLE
APPLICATION Bourdon tube Material	Adjustable Operating Range PSIG	Range No.	DA-31	DA-531	DS-231
Brass Bourdon Tubes	0-30 Hg Vac	2	2" Hg.	1" Hg.	0.2" Hg.
	10" Hg Vac 12	3	1 psig	0.5 psig	2 oz.
	1/8-15 psig	1	1 psig	0.5 psig	2 oz.
	1/8-20 psig	3A	1 psig	0.5 psig	2 oz.
	1-35 psig	4	1.75 psig	0.75 psig	4 oz.
	25" Hg Vac 50	27	3.5 psig	2 psig	7 oz.
	2-60 psig	5	3 psig	1 psig	6 oz.
	5-100 psig	6	3.75 psig	2 psig	7 oz.
	5-150 psig	7	6 psig	3 psig	8 oz.
	10-200 psig	8	8 psig	3.5 psig	12 oz.
10-300 psig	9	12 psig	6 psig	16 oz.	
			DA-21	DA-521	DS-221
403 Stainless Steel Bourdon Tubes	30" Hg Vac 60	25S	6 psig	3 psig	12 oz.
	30" Hg Vac 75	26S	8 psig	4 psig	12 oz.
	2-60 psig	5S	4 psig	2.5 psig	0.5 psig
	5-100 psig	6S	6 psig	3 psig	0.75 psig
	10-200 psig	8S	8 psig	4 psig	0.75 psig
	10-300 psig	9S	14 psig	7 psig	1 psig
	40-350 psig	9AS	14 psig	7 psig	1 psig
	25-600 psig	10S	25 psig	15 psig	2.5 psig
	50-1000 psig	11S	60 psig	40 psig	10 psig
	100-1500 psig	12S	90 psig	50 psig	12 psig
	300-2500 psig	13S	150 psig	100 psig	45 psig
	500-5000 psig	15S	450 psig	200 psig	150 psig
	800-8000 psig	16S	750 psig	400 psig	200 psig
			DA-41	DA-541	DS-241
316 Stainless Steel Bourdon Tubes	30" Hg Vac 75	26E	7 psig	35 psig	14 oz.
	5-75 psig	23E	3 psig	2 psig	0.4 psig
	10-100 psig	6E	7 psig	3.5 psig	14 oz.
	10-150 psig	24E	6 psig	3 psig	0.75 psig
	10-300 psig	9E	18 psig	5 psig	3 psig
	30-400 psig	21E	30 psig	15 psig	5 psig
	75-800 psig	22E	75 psig	35 psig	12 psig
	100-1000 psig	11E	100 psig	45 psig	18 psig
	200-2500 psig	13E	210 psig	110 psig	50 psig

Note: Differentials listed are for SP-ST operation only. When controls incorporate two mercury switches for double throw or two pole operation, the differentials are approximately double those shown for standard single pole, single throw controls.

**Two-Stage Pressure Controls, Series D-400
Ranges and Differentials**

Range No.	Adj. Working Range	Bourdon Tube Material	Minimum Pressure Spread Between Switch Operation	Fixed Differential Each Switch (Sensitivity)
For Steam and Other Applications: DA-431, -DAW-433, DAH-431				
1	1/8 - 15 psig	Brass	2-1/2 psig	1/2 psig
2	0-30" Hg. Vac.	Brass	4" Hg.	1" Hg. Vac.
3	10" Vac 12 psig	Brass	2-1/2 psig	1/2 psig
3A	1/8 - 20 psig	Brass	2-1/2 psig	1/2 psig
4	1-35 psig	Brass	3-1/2 psig	3/4 psig
5	2-60 psig	Brass	5 psig	3/4 psig
6	5-100 psig	Brass	7 psig	1 psig
7	5-150 psig	Brass	10-5/8 psig	1-1/8 psig
8	5-200 psig	Brass	15 psig	1-1/4 psig
9	10-300 psig	Brass	25 psig	2 psig
27	25" Vac 50 psig	Brass	7 psig	1 psig
For General Pressure Applications: DA-421, -DAW-423, DAH-421				
5S	2-60 psig	Steel	6 psig	1-1/4 psig
6S	5-100 psig	Steel	8 psig	2 psig
8S	10-200 psig	Steel	10 psig	2 psig
9S	10-300 psig	Steel	20 psig	4 psig
9AS	40-350 psig	Steel	20 psig	4 psig
10S	25-600 psig	Steel	40 psig	7 psig
11S	50-1000 psig	Steel	100 psig	10 psig
12S	100-1500 psig	Steel	150 psig	12 psig
13S	300-2500 psig	Steel	250 psig	20 psig
15S	500-5000 psig	Steel	600 psig	150 psig
25S	30" Hg. Vac. 60 psig	Steel	5 psig	1 psig
26S	30" Hg. Vac. 75 psig	Steel	10 psig	2 psig
316 S.S. Bourdon Tubes: DA-441, -DAW-443, DAH-441				
26E	30" Hg. Vac 75	316 S.S.	12 psig	2 psig
23E	5-75 psig	316 S.S.	12 psig	2 psig
6E	10-100 psig	316 S.S.	12 psig	2 psig
24E	10-150 psig	316 S.S.	13 psig	3 psig
9E	10-300 psig	316 S.S.	35 psig	6 psig
21E	30-400 psig	316 S.S.	40 psig	8 psig
22E	75-800 psig	316 S.S.	85 psig	15 psig
11E	100-1000 psig	316 S.S.	125 psig	22 psig
13E	200-2500 psig	316 S.S.	275 psig	75 psig

**Two Stage, Series D-400
Switch Operating Specifications**

When ordering, select operation desired, add suffix number to type number of control. Example: Type DA-431-4122.

Spec. No. Pressure	Switch Mk.	Contact Position		
		Low Pressure Hi-Vac.	Intermediate Pressure	High Pressure Lo-Vac.
-4122	"A"	ON	OFF	OFF
	"B"	ON	ON	OFF
-4129	"A"	OFF	ON	ON
	"B"	OFF	OFF	ON
-4132	"A"	ON	OFF	OFF
	"B"	OFF	OFF	ON
-4123	"A"	OFF	ON	ON
	"B"	ON	ON	OFF

Specification No. 4122. One circuit opens on increase of pressure; second circuit opens on further increase of pressure.

Specification No. 4129. One circuit closes on increase of pressure; second circuit closes on further increase of pressure.

Specification No. 4132. Both circuits open at intermediate pressure. One circuit closes on increase of pressure above neutral zone; second circuit closes on decrease in pressure below neutral zone.

Specification No. 4123. Both circuits close at intermediate pressure. One circuit opens on increase of pressure above neutral zone; second circuit opens on decrease in pressure below neutral zone.

Electrical Ratings D-400

See Code C on Page 4 in Electrical Rating Chart.

Suffix No.	Circuit	Code	Circuit Response to Pressure Increase
-2		SP-ST	A Opens
-3		SP-ST	A Closes
-4		DP-ST	B Closes
-26		SP-ST	A* Closes
-36		SP-ST	A* Opens
-54		DP-ST	B Opens
-103		DP-ST	A Closes
-113		DP-ST	A* Closes
-127		DP-ST	A Opens
-152		SP-DT	B One Closes as Other Opens
-153		SP-DT	B One Closes as Other Opens
-154		2 Circuits 1 Circuit	B Close Opens
-155		1 Circuit 2 Circuit	B Closes Open
-156		SP-DT	A One Closes as Other Opens
-705		SP-DT SP-ST	B A One Opens as Other Closes Closes
-729		SP-DT ST-ST	B A One Closes as Other Opens Opens
-804		DP-DT	B Two Close Two Open
-815			B 4P-ST Close (2) 9-67
-816			B 4P-ST Open (2) 9-67

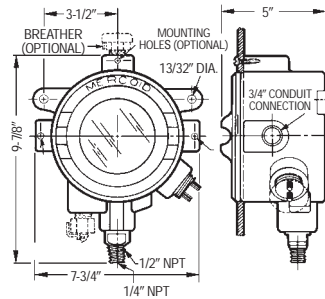

Explosion-Proof
Prefixed by DAH, DAHF
DRH, DSH, DSHF

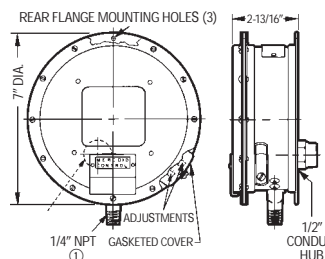

Watertight NEMA 2, 3, 4 -
Prefixed by DAW, DRW,
DSW, DLW

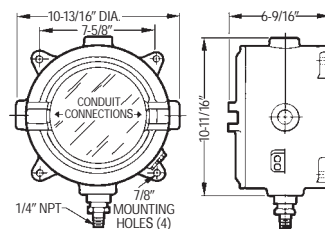

Explosion-Proof
Prefixed by DAE, DLE, DRE,
DSE

Electrical Rating Chart

Code	Circuit Suffix	AC Capacity			DC Capacity		Horsepower	
		120V.	240V.	440V.	120V.	240V.	AC	DC
A	-2, -3	10A.	5A.	3A.	10A.	5A.	3/4	1/3
	-153	4A.	2A.	1*	4A.	2A.	1/8	NA
B	-2, -3	5A.	2A.	NA.	2-1/2A.	1A.	1/8	1/10
C	-2, -3	0.3A.	0.15A.	NA	0.15A.	0.07A.	NA	NA

*Consult Factory